

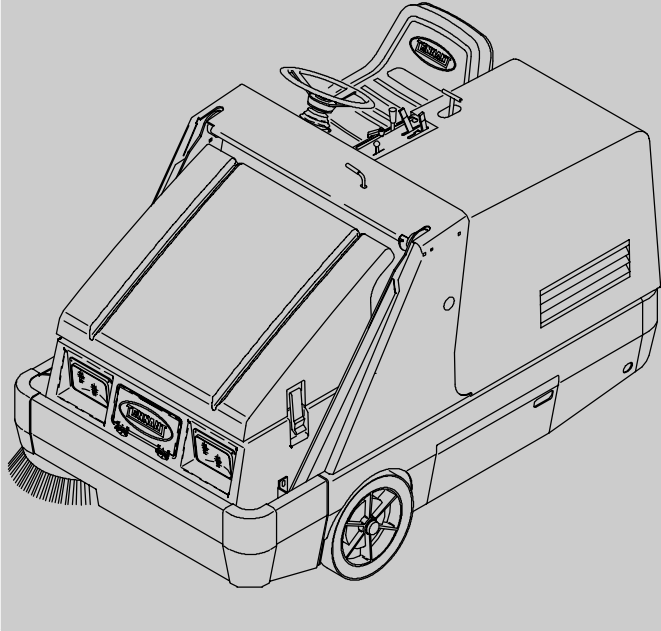

6400

(Electric)

Sweeper Operator Manual



North America / International

www.tennantco.com

MM432
Rev. 12 (04-2009)





This manual is furnished with each new model. It provides necessary operation and maintenance instructions.

Read this manual completely and understand the machine before operating or servicing it.

This machine will provide excellent service. However, the best results will be obtained at minimum costs if:

- The machine is operated with reasonable care.
- The machine is maintained regularly - per the machine maintenance instructions provided.
- The machine is maintained with manufacturer supplied or equivalent parts.

	PROTECT THE ENVIRONMENT Please dispose of packaging materials, old machine components such as batteries, hazardous fluids including antifreeze and oil, in an environmentally safe way according to local waste disposal regulations.
	Always remember to recycle.

MACHINE DATA	
Please fill out at time of installation for future reference.	
Model No. -	_____
Serial No. -	_____
Machine Options -	_____
Sales Rep. -	_____
Sales Rep. phone no. -	_____
Customer Number -	_____
Installation Date -	_____

Tennant Company
PO Box 1452
Minneapolis, MN 55440
Phone: (800) 553-8033 or (763) 513-2850
www.tennantco.com

Thermo-Sentry, Instant Access, and Perma-Filter are US registered and unregistered trademarks of Tennant Company.

Specifications and parts are subject to change without notice.

Original instructions, Copyright © 1996-2000, 2001, 2002, 2004, 2006-2009 TENNANT Company, Printed in U.S.A.

CONTENTS

	Page		Page
SAFETY PRECAUTIONS	3	DISENGAGING HOPPER SUPPORT	
OPERATION	5	BAR	33
OPERATOR RESPONSIBILITY	5	OPERATION ON INCLINES	34
MACHINE COMPONENTS	6	OPTIONS	35
SYMBOL DEFINITIONS	7	VACUUM WAND	35
CONTROLS AND INSTRUMENTS	9	MACHINE TROUBLESHOOTING	37
OPERATION OF CONTROLS	10	MAINTENANCE	38
DIRECTIONAL PEDAL	10	MAINTENANCE CHART	38
BRAKE PEDAL	11	LUBRICATION	40
PARKING BRAKE PEDAL	11	PROPELLING GEARBOX	40
SEAT SUPPORT RELEASE LEVER ..	11	REAR WHEEL SUPPORT	40
HOPPER LEVER	12	STEERING LINK	41
HOPPER DOOR LEVER	12	FRONT WHEEL BEARINGS	41
MAIN BRUSH LEVER	12	HOPPER LIFT ARM PIVOTS	41
MAIN BRUSH DOWN		HYDRAULICS	42
PRESSURE KNOB	13	HYDRAULIC FLUID RESERVOIR	42
VACUUM AND FILTER		HYDRAULIC FLUID	42
SHAKER LEVER	13	HYDRAULIC HOSES	43
POWER KILL SWITCH (OPTION)	13	BATTERIES	44
CLOGGED FILTER LIGHT (OPTION) .	14	CHARGING THE BATTERIES	45
HOPPER TEMPERATURE LIGHT -		ELECTRIC MOTORS	47
THERMO SENTRY	14	BELTS AND CHAINS	47
HOPPER DOOR CLOSED LIGHT		HYDRAULIC PUMP BELT	47
(OPTION)	14	VACUUM FAN BELT	48
HYDRAULIC FILTER BYPASS LIGHT		MAIN BRUSH INTERMEDIATE BELT .	48
(OPTION)	14	MAIN BRUSH BELT	48
BATTERY DISCHARGE INDICATOR .	15	STATIC DRAG CHAIN	48
STEERING WHEEL	15	DEBRIS HOPPER	49
HOURLMETER	15	HOPPER DUST FILTER	49
STEERING WHEEL TILT HANDLE ...	16	REMOVING HOPPER DUST	
ON-OFF KEY SWITCH	16	FILTER	50
HORN BUTTON	16	BRUSHES	51
SIDE BRUSH LEVER	16	MAIN BRUSH	51
OPERATING LIGHTS SWITCH		REPLACING MAIN BRUSH	51
(OPTION)	17	CHECKING AND ADJUSTING	
OPERATING/HAZARD LIGHTS		MAIN BRUSH PATTERN	52
SWITCH (OPTION)	17	SIDE BRUSH	54
SIDE BRUSH DOWN PRESSURE		REPLACING SIDE BRUSH	54
KNOB	17	SIDE BRUSH GUARD	55
FUSES	18	SIDE BRUSH PIVOT	55
CIRCUIT BREAKERS	18	SKIRTS AND SEALS	56
OPERATOR SEAT	19	HOPPER LIP SKIRT	56
DELUXE SUSPENSION SEAT		HOPPER SIDE SKIRT	56
(OPTION)	19	BRUSH DOOR SKIRTS	56
HOPPER SUPPORT BAR	20	REAR SKIRTS	57
HOW THE MACHINE WORKS	21	SIDE BRUSH DUST CONTROL	
PRE-OPERATION CHECKLIST	21	SKIRTS (OPTION)	57
STARTING THE MACHINE	22	BRUSH DOOR SEALS	57
SWEEPING AND BRUSH		HOPPER SEALS	57
INFORMATION	23	HOPPER ACCESS DOOR SEAL	58
SWEEPING	25	HOPPER DOOR SEALS	58
STOP SWEEPING	26	VACUUM FAN SEAL	58
EMPTYING THE HOPPER	27	BRAKES AND TIRES	59
STOP THE MACHINE	29	BRAKES	59
POST-OPERATION CHECKLIST	30	TIRES	59
ENGAGING HOPPER SUPPORT BAR ..	31	REAR WHEEL	59

CONTENTS

	Page
PUSHING, TOWING, AND TRANSPORTING THE MACHINE	60
PUSHING OR TOWING THE MACHINE	60
TRANSPORTING THE MACHINE	60
MACHINE JACKING	62
STORING MACHINE	62
SPECIFICATIONS	63
GENERAL MACHINE PERFORMANCE . .	63
POWER TYPE	64
STEERING	64
HYDRAULIC SYSTEM	64
BRAKING SYSTEM	64
TIRES	64
MACHINE DIMENSIONS	65
INDEX	66

SAFETY PRECAUTIONS

The following symbols are used throughout this manual as indicated in their description:



WARNING: To warn of hazards or unsafe practices that could result in severe personal injury or death.

FOR SAFETY: To identify actions that must be followed for safe operation of equipment.

The machine is suited to sweep disposable debris. Do not use the machine other than described in this Operator Manual. The machine is not designed for use on public roads.

The following information signals potentially dangerous conditions to the operator or equipment:



WARNING: Batteries emit hydrogen gas. Explosion or fire can result. Keep sparks and open flame away. Keep covers open when charging.



WARNING: Lift arm pinch point. Stay clear of hopper lift arms.



WARNING: Raised hopper may fall. Engage hopper support bar.



WARNING: Moving belt and fan. Keep away.

FOR SAFETY:

1. **Do not operate machine:**
 - Unless trained and authorized.
 - Unless operation manual is read and understood.
 - In flammable or explosive areas unless designed for use in those areas.
 - In areas with possible falling objects unless equipped with overhead guard.
2. **Before starting machine:**
 - Make sure all safety devices are in place and operate properly.
 - Check brakes and steering for proper operation.
3. **When starting machine:**
 - Keep foot on brake and directional pedal in neutral.

4. **When using machine:**
 - Do not pick up burning or smoking debris, such as cigarettes, matches or hot ashes.
 - Use brakes to stop machine.
 - Go slowly on inclines and slippery surfaces.
 - Use care when reversing machine.
 - Move machine with care if hopper is raised.
 - Make sure adequate clearance is available before raising hopper.
 - Do not carry riders on machine.
 - Always follow safety and traffic rules.
 - Report machine damage or faulty operation immediately.

5. **Before leaving or servicing machine:**
 - Stop on level surface.
 - Set parking brake.
 - Turn off machine and remove key.

6. **When servicing machine:**
 - Avoid moving parts. Do not wear loose jackets, shirts, or sleeves when working on machine.
 - Block machine tires before jacking up machine.
 - Jack up machine at designated locations only. Block machine up with jack stands.
 - Use hoist or jack that will support the weight of the machine.
 - Wear eye and ear protection if using pressurized air or water.
 - Disconnect battery connections before working on machine.
 - Avoid contact with battery acid.
 - Use cardboard to locate leaking hydraulic fluid under pressure.
 - Use Tennant supplied or equivalent replacement parts.

7. **When loading/unloading machine onto/off truck or trailer:**
 - Turn off machine.
 - Use truck or trailer that will support the weight of the machine.
 - Use winch. Do not drive the machine onto/off the truck or trailer unless the load height is 380 mm (15 in) or less from the ground.
 - Set parking brake after machine is loaded.
 - Block machine tires.
 - Tie machine down to truck or trailer.

SAFETY PRECAUTIONS

The following safety labels are mounted on the machine in the locations indicated. If these or any labels become damaged or illegible, install a new label in its place.

FOR SAFETY LABEL - LOCATED ON THE SIDE OF THE OPERATOR COMPARTMENT.



BATTERY CHARGING LABEL - LOCATED ON THE CONTROL BOX.

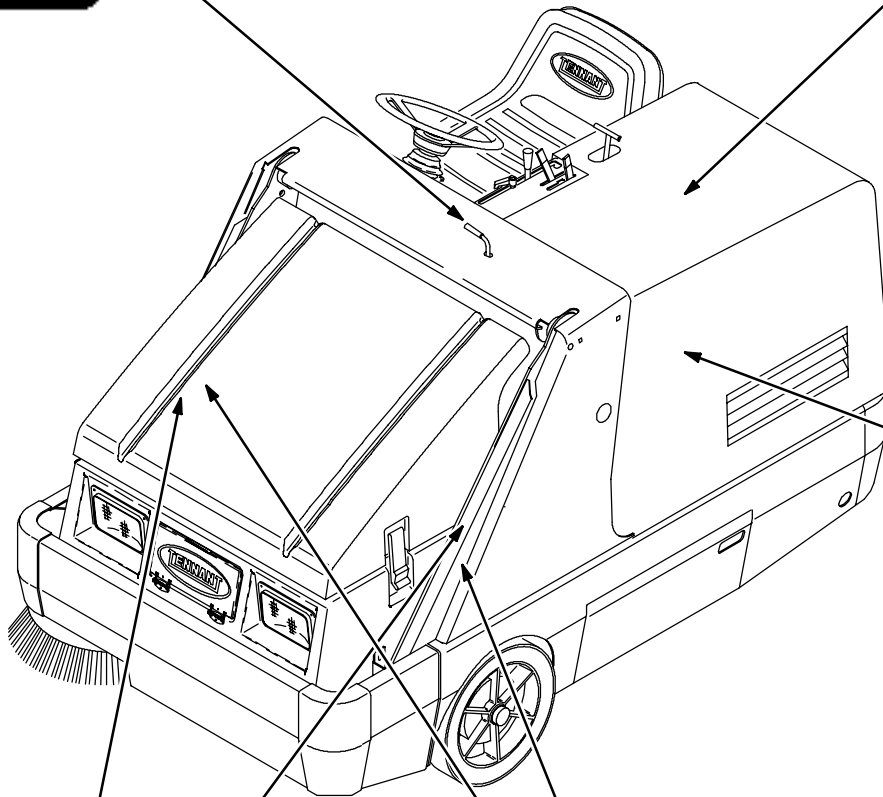

FAN AND BELT LABEL - LOCATED ON THE VACUUM FAN PLATE AND BELT SHROUD.



HOPPER SUPPORT LABEL - LOCATED ON BOTH LIFT ARMS AND THE HOPPER SUPPORT BAR.



HOPPER LIFT ARMS LABEL - LOCATED ON BOTH LIFT ARMS.

350159

OPERATION

OPERATOR RESPONSIBILITY

- The operator's responsibility is to take care of the daily maintenance and checkups of the machine to keep it in good working condition. The operator must inform the service mechanic or supervisor when the maintenance intervals are required as stated in the *MAINTENANCE* section of this manual.
- Read this manual carefully before operating the machine. View the operation video supplied with the machine.

FOR SAFETY: Do not operate machine, unless operation manual is read and understood.

- Check the machine for shipping damage. Check to make sure the machine is complete per shipping instructions.
- Keep your machine regularly maintained by following the maintenance information in this manual. We recommend taking advantage of a regularly scheduled service contract from your Tennant representative.
- Order parts and supplies directly from your authorized Tennant representative. Use the parts manual provided when ordering parts.
- After the first 50 hours of operation, follow the recommended procedures stated in the *MAINTENANCE CHART*.

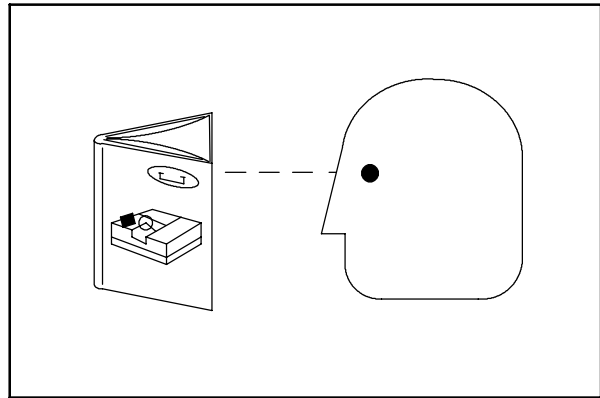

07324

OPERATION

MACHINE COMPONENTS

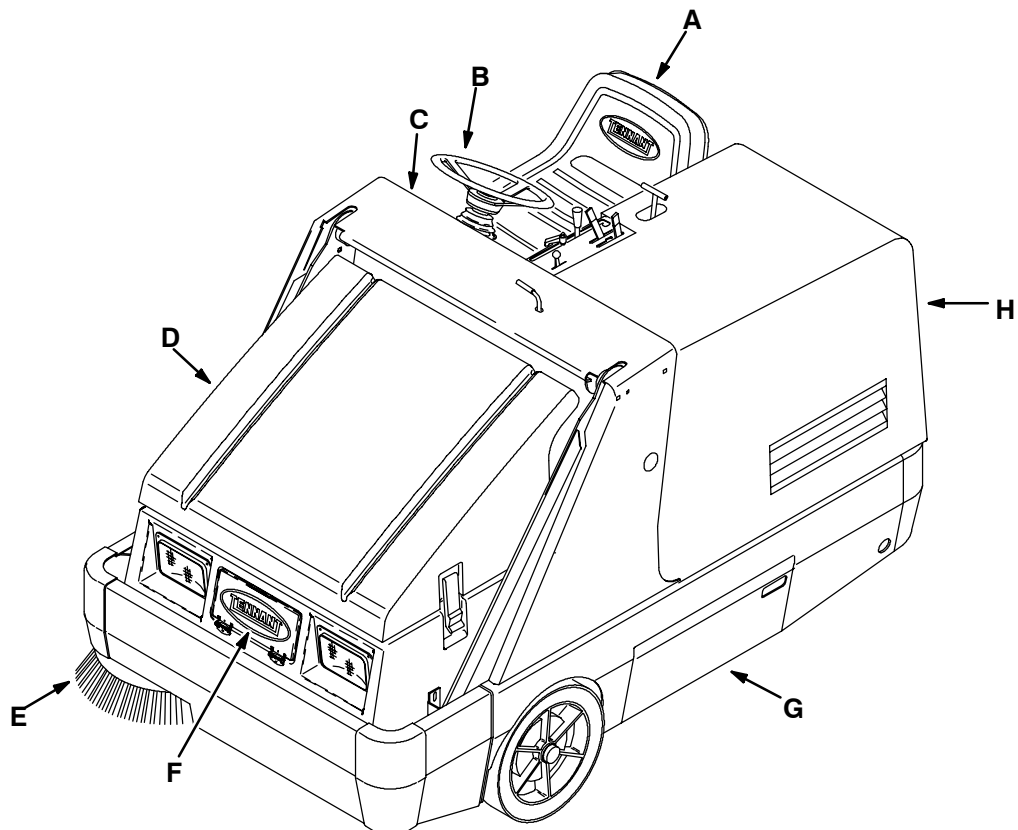

- A. Operator seat
- B. Steering wheel
- C. Instrument panel
- D. Hopper cover
- E. Side brush
- F. Hopper access door
- G. Brush door
- H. Seat support

350159

SYMBOL DEFINITIONS

These symbols identify controls, displays, and features on the machine:



Filter shaker



Vacuum fan on



Vacuum fan off



Hopper down



Hopper up



Hopper door open



Hopper door close



Main brush down and on



Main brush up and off



Battery charging system



Clogged dust filter



Thermo Sentry



Hopper door closed



Hydraulic filter clogged



Hourmeter



Steering wheel tilt



Off



On



Start



Horn



Side brush down and on



Side brush up and off



Operating lights



Hazard light



Variable pressure



Side brush pressure

1
——

Circuit breaker #1

2
——

Circuit breaker #2

3
——

Circuit breaker #3

4
——

Circuit breaker #4

CONTROLS AND INSTRUMENTS

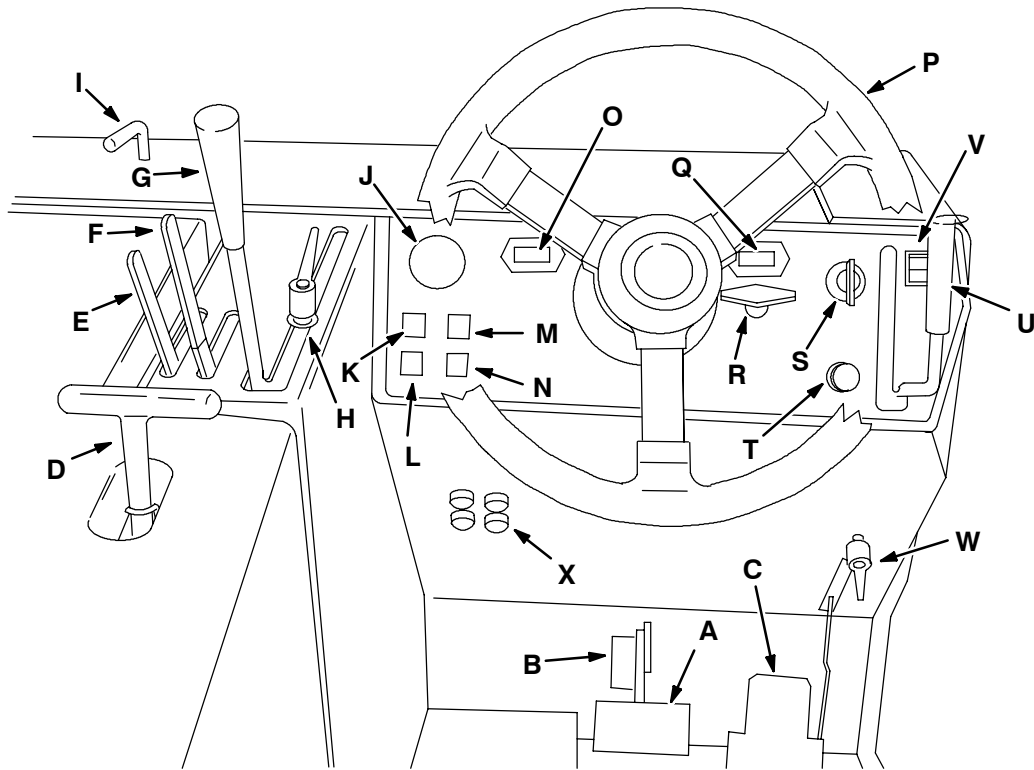

350014

- A. Brake pedal
- B. Parking brake pedal
- C. Directional pedal
- D. Seat support release lever
- E. Hopper lever
- F. Hopper door lever
- G. Main brush lever
- H. Main brush down pressure knob
- I. Vacuum and filter shaker lever
- J. Power kill switch (option)
- K. Clogged filter light (option)
- L. Hopper temperature light - Thermo Sentry
- M. Hopper door closed light (option)
- N. Hydraulic filter bypass light (option)
- O. Battery discharge indicator
- P. Steering wheel
- Q. Hourmeter
- R. Steering wheel tilt handle
- S. On-off key switch
- T. Horn button
- U. Side brush lever
- V. Operating/hazard light switch (option)
- W. Side brush down pressure knob
- X. Circuit breakers

OPERATION

OPERATION OF CONTROLS

DIRECTIONAL PEDAL

The directional pedal controls the direction of travel and the propelling speed of the machine. You change the speed of the machine with the pressure of your foot on the pedal; the harder you press the faster the machine travels.

The machine will coast for a short distance before changing direction when the directional pedal is reversed. Use the brake pedal to stop the machine.

Forward: Press the top of the directional pedal with the toe of your foot.

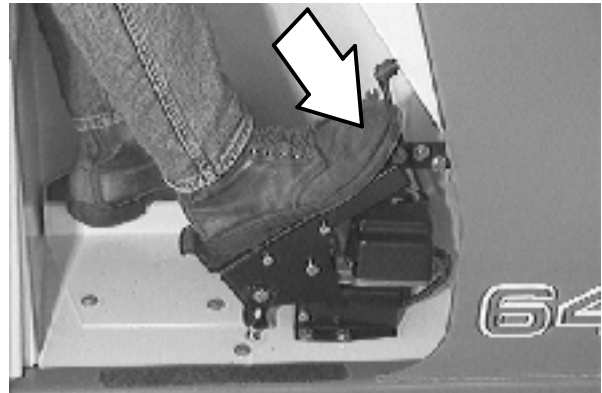

Reverse: Press the bottom of the directional pedal with the heel of your foot.

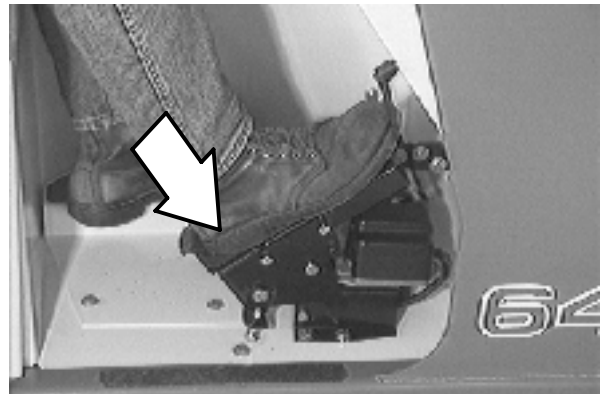

Neutral: Take your foot off the directional pedal and it will return to the **Neutral** position.

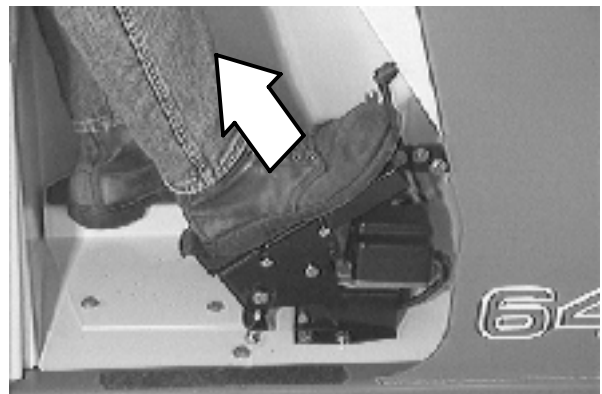

BRAKE PEDAL

The brake pedal stops the machine.

Stop: Take your foot off the directional pedal and let it return to the **Neutral** position. Step on the brake pedal.

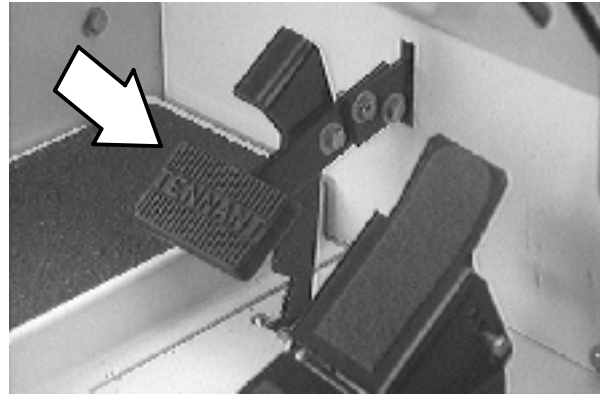
**PARKING BRAKE PEDAL**

The parking brake pedal sets and releases the front wheel brakes.

Set: Press on the brake pedal as far as possible, then press on the parking brake pedal with the toe portion of your foot to lock the parking brake pedal in place.

FOR SAFETY: Before leaving or servicing machine, stop on level surface, set parking brake, turn off machine, and remove key.

Release: Press on the brake pedal to unlock the parking brake pedal.

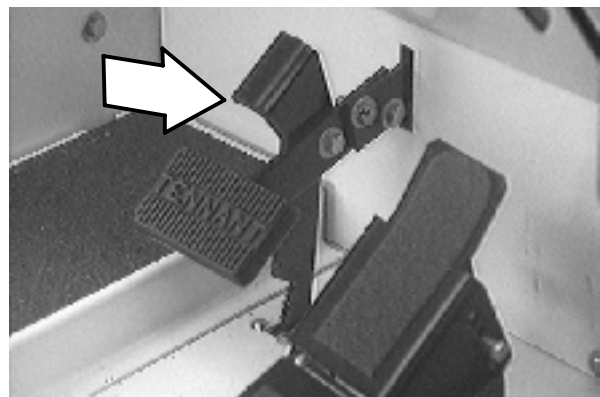
**SEAT SUPPORT RELEASE LEVER**

The seat support lever releases and locks the seat support.

Release: Pull the release lever back and lift the seat support.

Lock: Close the seat support and release the lever to lock the support in place.

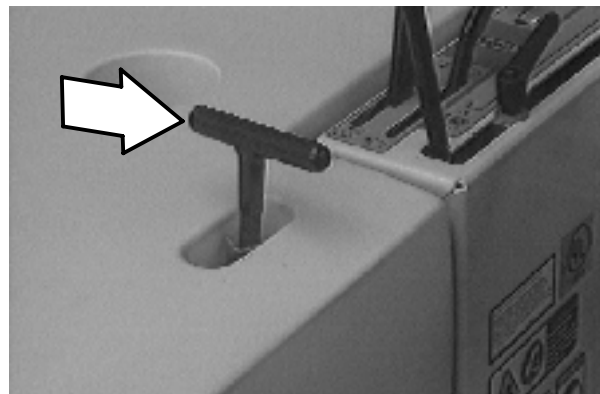

OPERATION

HOPPER LEVER

The hopper lever raises and lowers the hopper.

Hopper up: Pull the hopper lever into the **Hopper up** position.

Hold: Release the hopper lever into the middle position.

Hopper down: Push the hopper lever into the **Hopper down** position.

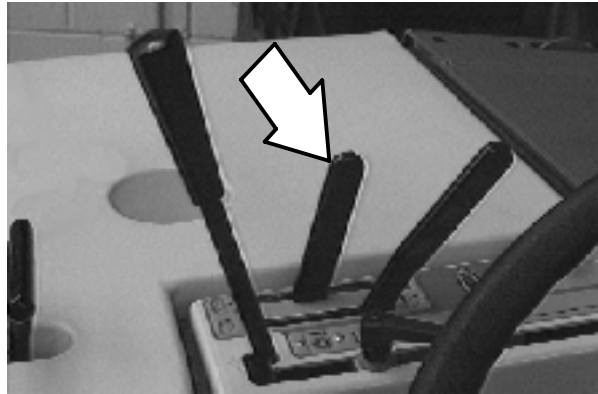

HOPPER DOOR LEVER

The hopper door lever opens and closes the hopper door. Open the hopper door before sweeping. Close the hopper door when emptying the hopper to control debris and dust.

Hopper door open: Push the hopper door lever forward into the **Hopper door open** position.

Hopper door close: Pull the hopper door lever back into the **Hopper door close** position for a few seconds until the hopper door is closed.

NOTE: If the machine is equipped with the hopper door closed light option, the light will come on when the hopper door is closed.

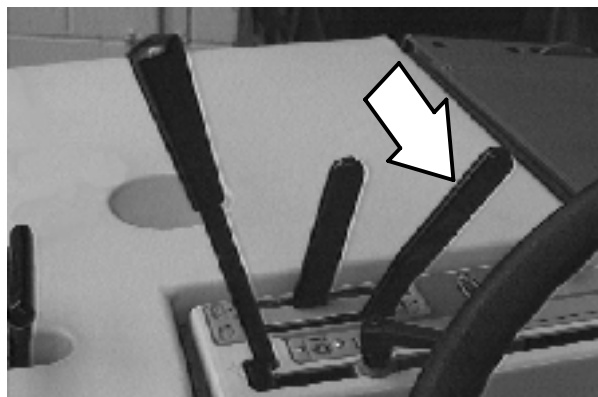

MAIN BRUSH LEVER

The main brush lever controls the position and rotation of the main brush.

Main brush down and on: Pull the lever back and to the right into the **Main brush down and on** position against the main brush down pressure knob. The brush will automatically start rotating.

Main brush up and off: Pull the lever back and to the left into the **Main brush up and off** position.

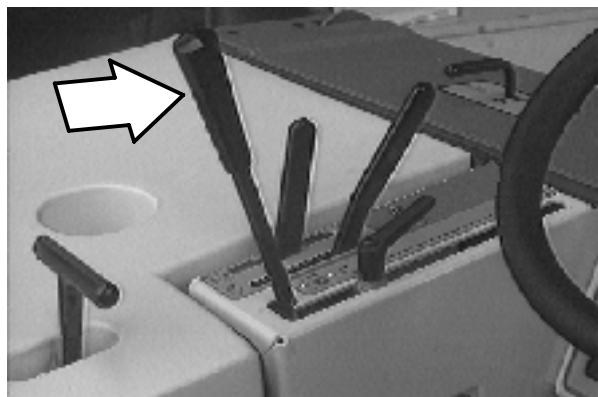

MAIN BRUSH DOWN PRESSURE KNOB

The main brush down pressure knob changes the amount of contact the main brush has with the surface being swept.

Increase: Loosen the main brush down pressure knob. Move the knob forward, away from the operator, and retighten it.

Decrease: Loosen the main brush down pressure knob. Move the knob back, towards the operator, and retighten it.

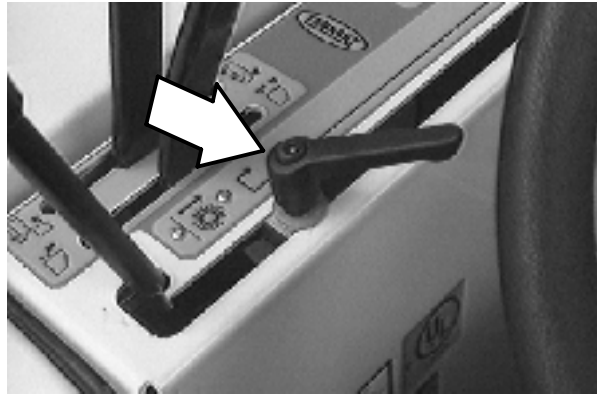

VACUUM AND FILTER SHAKER LEVER

The vacuum and filter shaker lever controls the vacuum fan duct and the filter shaker. The vacuum fan duct should be on when sweeping dry debris. The vacuum fan duct should be off when sweeping wet debris.

Vacuum Fan on: Turn the lever to the left into the **Vacuum Fan on** position.

Vacuum Fan off: Turn the lever to the right into the **Vacuum Fan off** position.

Start filter shaker: Place the lever in the **Filter shaker** position for 30 seconds.

*Note: Excessive heat in the hopper will cause the Thermo Sentry™ to move the vacuum and filter shaker lever to the **Vacuum fan off** position. It will also make the hopper temperature light come on. If this happens, stop the machine, eliminate the source of the heat, and return the lever to the **Vacuum fan on** position.*

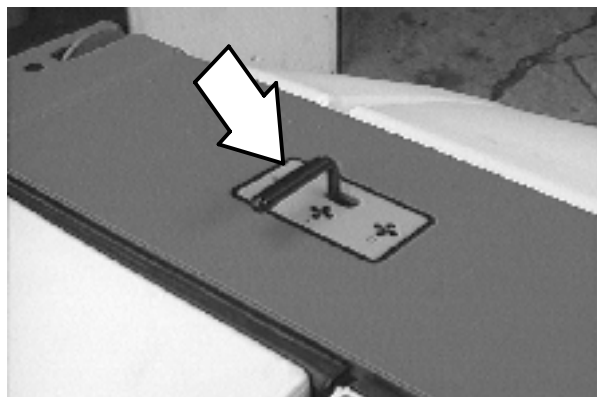

POWER KILL SWITCH (OPTION)

The power kill switch halts all power to the machine.

Halt: Push the power kill switch in.

Restart: Turn off the machine power. Turn the power kill switch to the right to release the switch. Turn on the machine power.

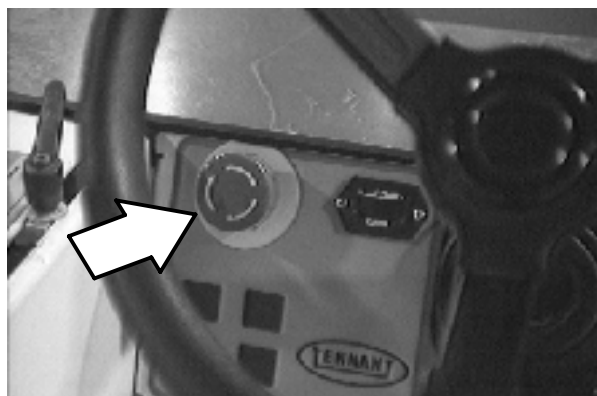

OPERATION

CLOGGED FILTER LIGHT (OPTION)

The clogged filter light comes on when the hopper dust filter is clogged.

To clean the filter, hold the vacuum and filter shaker lever in the **Filter shaker** position. If the clogged filter light remains lit, manually clean the hopper dust filter. See *HOPPER DUST FILTER* in the *MAINTENANCE* section of this manual.

NOTE: The clogged filter light also comes on when the hopper door is closed and the vacuum fan is on.

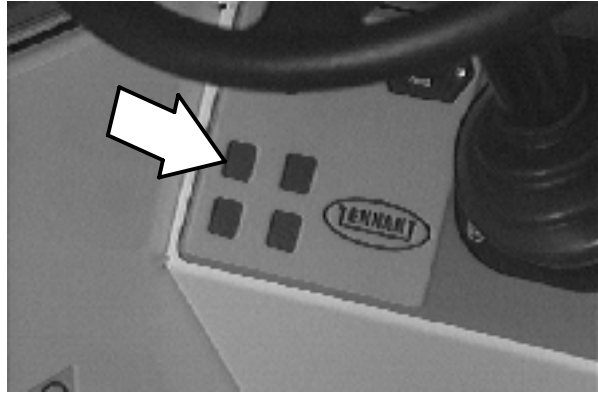

HOPPER TEMPERATURE LIGHT - THERMO SENTRY

The hopper temperature light comes on when the Thermo Sentry senses that there is excessive heat in the hopper, possibly from a fire. The Thermo Sentry will also move the vacuum and filter shaker lever to the **Vacuum fan off** position. If this happens, stop the machine, eliminate the source of the heat, and return the lever to the **Vacuum fan on** position.

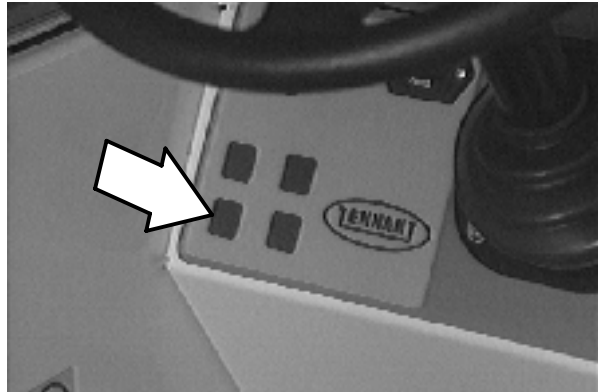

HOPPER DOOR CLOSED LIGHT (OPTION)

The hopper door closed light comes on when the hopper door is closed.

Make sure the hopper door is open all the way and the hopper door closed light is off, before sweeping.

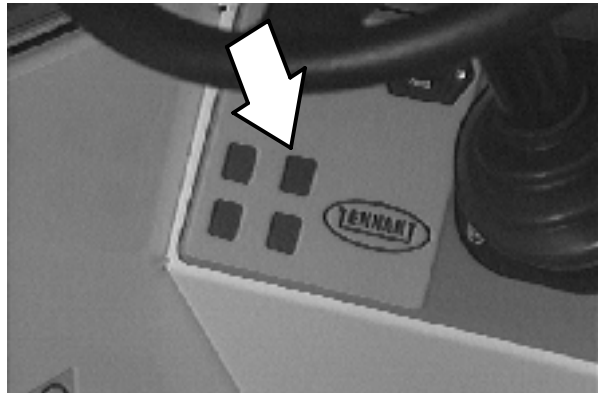

HYDRAULIC FILTER BYPASS LIGHT (OPTION)

The hydraulic filter bypass light comes on when the hydraulic filter is clogged. If this light comes on, have the hydraulic filter and hydraulic fluid changed as soon as possible.

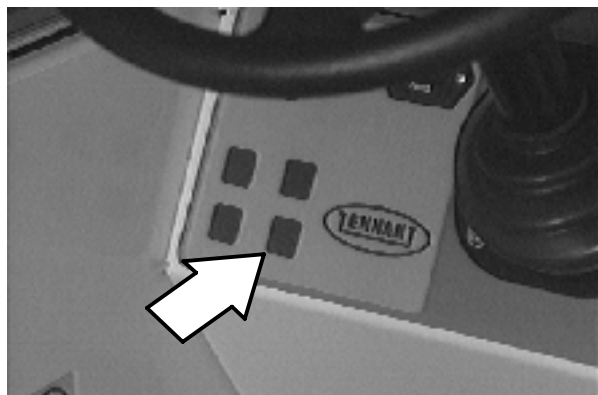

BATTERY DISCHARGE INDICATOR

The battery discharge indicator shows the charge level of the batteries. It displays the charge level when the machine is operating.

When the batteries are fully charged, the indicator on the far right is lit. As the batteries discharge, the indicator will move along the display to the left. Recharge the batteries when the indicator flashes.

NOTE: The reading on the battery discharge indicator is not accurate when the machine is first powered on. Operate the machine a few minutes before reading the charge level of the batteries.

NOTE: The battery discharge indicator will not reset from the flashing indicator unless the batteries have been fully charged.

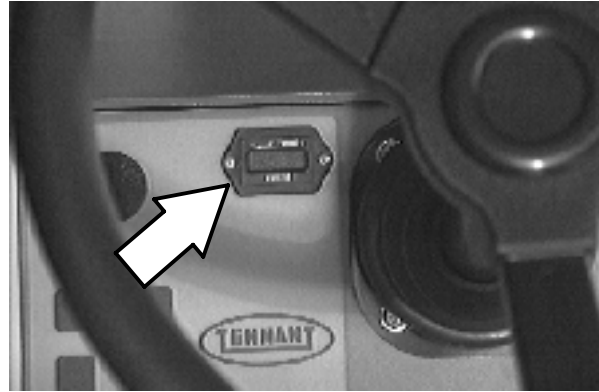

STEERING WHEEL

The steering wheel controls the machine's direction. The machine is very responsive to the steering wheel movements.

Left: Turn the steering wheel to the left.

Right: Turn the steering wheel to the right.



HOURMETER

The hourmeter records the number of hours the machine has been operated. The hourmeter displays the number of hours in tenths of an hour. Use this information to determine machine maintenance intervals.

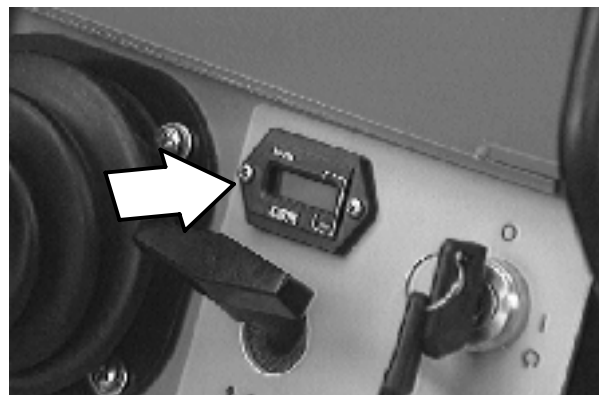

OPERATION

STEERING WHEEL TILT HANDLE

The steering wheel tilt handle controls the angle of the steering wheel.

Adjust: Pull out the tilt handle, move the steering wheel up or down, and release the tilt handle.

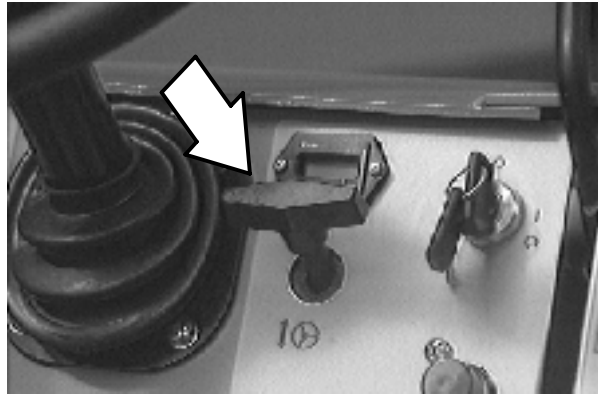

ON-OFF KEY SWITCH

The on-off key switch controls machine power with a key.

On: Turn the key clockwise all the way.

Off: Turn the key counterclockwise.

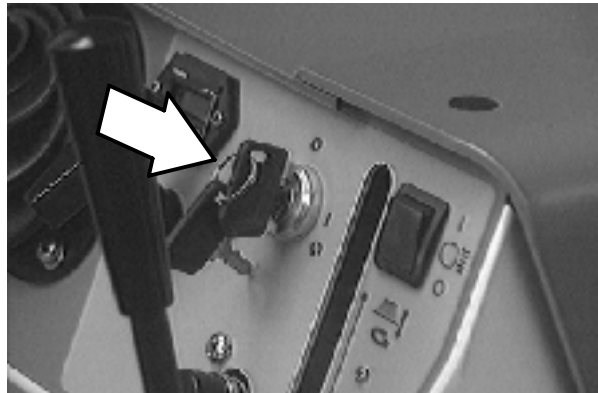

HORN BUTTON

The horn button operates the horn.

Sound: Press the button.

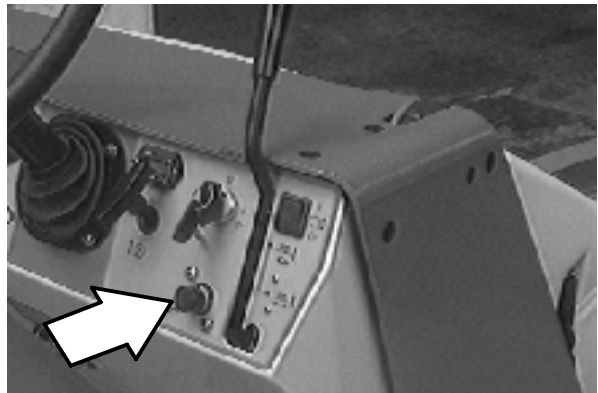

SIDE BRUSH LEVER

The side brush lever controls the position and rotation of the side brush.

Side brush down and on: Pull the lever back and to the left into the **Side brush down and on** position. The brush will automatically start rotating.

Side brush up and off: Pull the lever back and to the right into the **Side brush up and off** position.

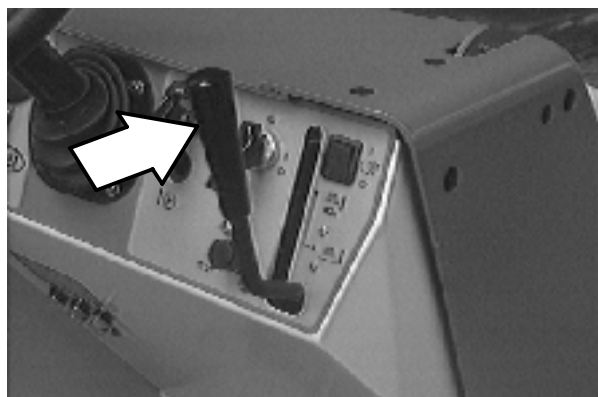

OPERATING LIGHTS SWITCH (OPTION)

The operating lights switch powers on and off the headlights and taillights option.

On: Press the top of the operating lights switch.

Off: Press the bottom of the operating lights switch.

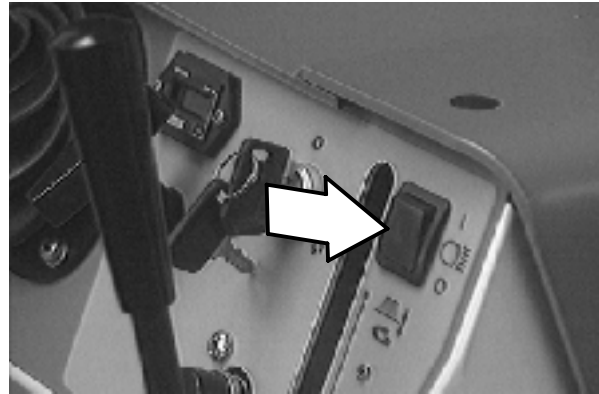
**OPERATING/HAZARD LIGHTS SWITCH (OPTION)**

The operating/hazard lights switch powers on and off the headlights and taillights option and the hazard light option.

Operating lights on: Press the top of the operating/hazard lights switch.

Operating/Hazard lights on: Press the bottom of the operating/hazard lights switch.

Off: Place operating/hazard lights switch in the middle position.

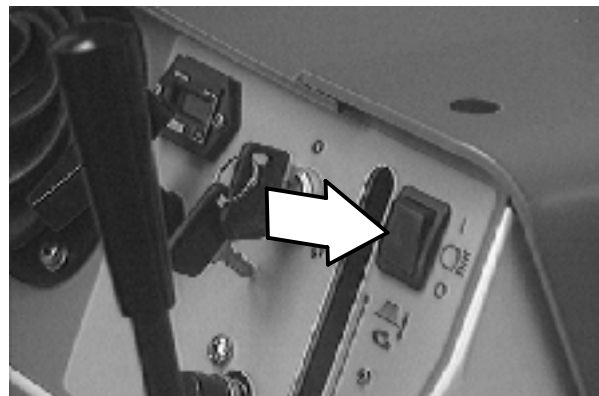
**SIDE BRUSH DOWN PRESSURE KNOB**

The side brush down pressure knob changes the side brush contact with the sweeping surface.

Increase: Turn the side brush down pressure knob counter-clockwise.

Decrease: Turn the side brush down pressure knob clockwise.



OPERATION

FUSES

Fuses are one-time protection devices designed to stop the flow of current in the event of a circuit overload. Never substitute higher value fuses than specified.

The fuses are located in the control box.

Fuse	Rating	Circuit Protected
FU-1	100 A	Hydraulic pump motor
FU-2	80 A	Propelling

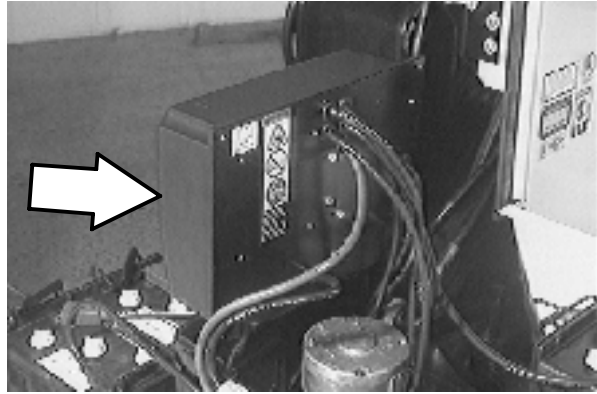

CIRCUIT BREAKERS

The circuit breakers are resettable electrical circuit protection devices. Their design stops the flow of current in the event of a circuit overload. Once a circuit breaker is tripped, it must be reset manually. Press the reset button after the breaker has cooled down.

If the overload that caused the circuit breaker to trip is still there, the circuit breaker will continue to stop current flow until the problem is corrected.

The circuit breakers are located in the operator compartment.

The chart lists the circuit breakers and the electrical components they protect.

Circuit Breaker	Rating	Circuit Protected
CB-1	15 A	Thermo Sentry™
CB-2	15 A	Instrument panel, seat switch
CB-3	15 A	Operating lights
CB-4	15 A	Horn

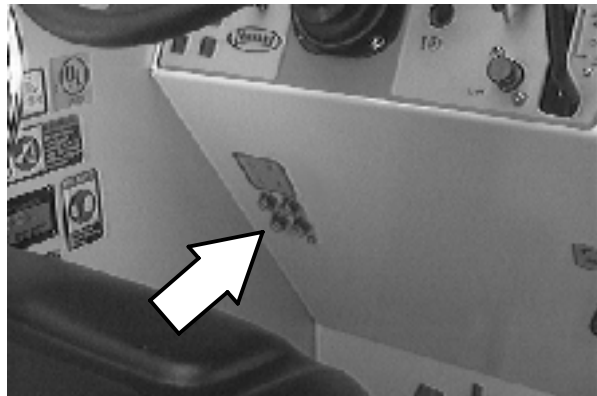

OPERATOR SEAT

The operator seat is a fixed back style with a forward-backward adjustment.

Adjust: Pull the lever in, slide the seat backward or forward to the desired position, and release the lever.

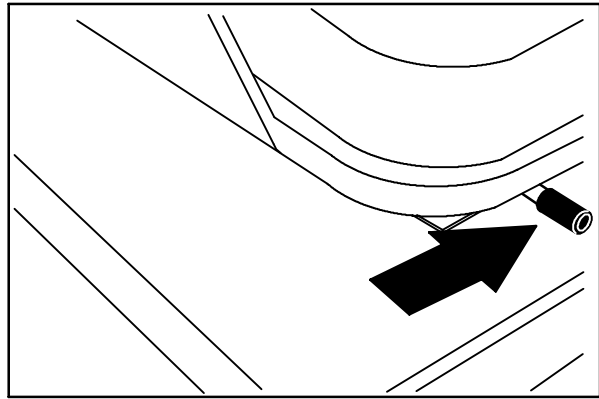

350015

DELUXE SUSPENSION SEAT (OPTION)

The deluxe suspension seat has three adjustments. The adjustments are for the operator's weight, backrest angle, and the front-to-rear seat position.

The operator's weight adjustment lever controls the seat weight adjustment. The lever has three positions: lightweight, middleweight, and heavyweight.

Adjust: Pull the lever up for the lightweight position, move the lever to the middle position for middleweight, and push the lever down for the heavyweight position.

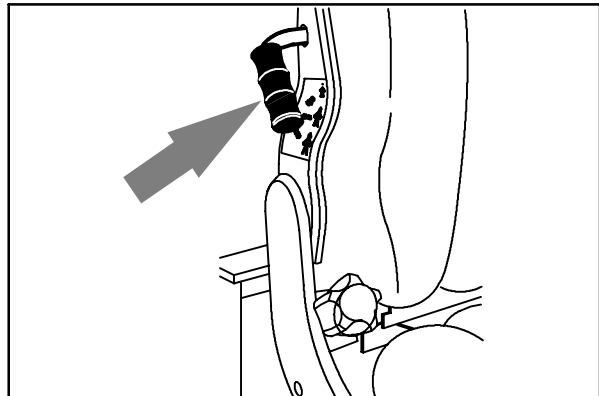

07795

The backrest angle knob adjusts the backrest angle.

Adjust: Turn the angle knob clockwise to decrease the angle of the backrest. Turn the knob counterclockwise to increase the angle of the backrest.

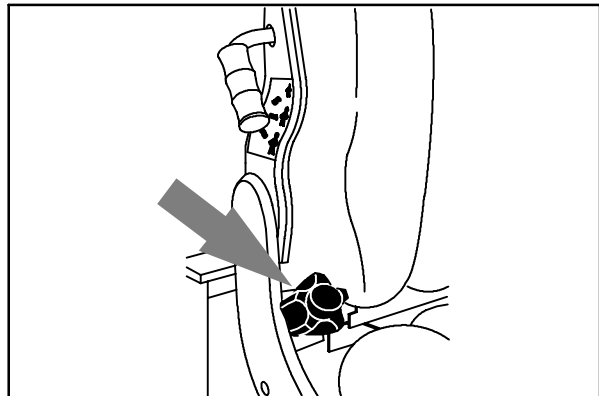

07796

The seat front-to-rear position lever adjusts the seat position.

Adjust: Pull the lever out, slide the seat backward or forward to the desired position and release the lever.

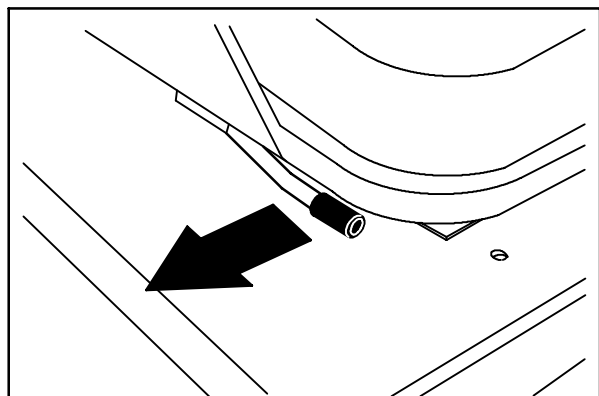

07797

OPERATION

HOPPER SUPPORT BAR

The hopper support bar is located on the operator's side of the hopper lift arms. The hopper support bar holds the hopper in the raised position to allow work under the hopper. DO NOT rely on the machine hydraulic system to keep the hopper raised.



**WARNING: Raised hopper may fall.
Engage hopper support bar.**

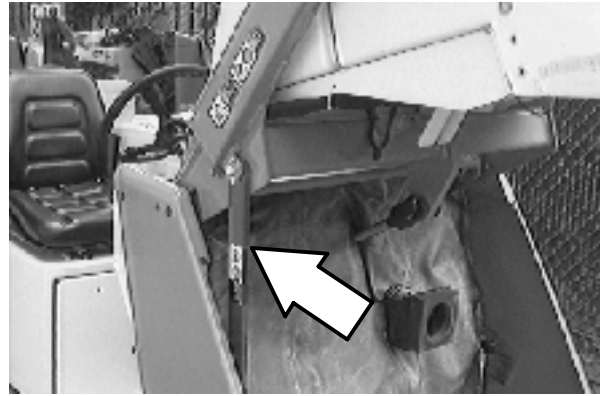

HOW THE MACHINE WORKS

The steering wheel controls the direction of machine travel. The directional pedal controls the speed and forward/reverse direction. The brake pedal slows and stops the machine.

The side brush sweeps debris into the path of the main sweeping brush. The main brush sweeps debris from the floor into the hopper. The vacuum system pulls dust and air through the hopper and the hopper dust filter.

When sweeping is finished, clean the hopper dust filter and empty the hopper.

PRE-OPERATION CHECKLIST

- Check the hydraulic fluid level. (if applicable)
- Check the battery fluid and charge level.
- Check the skirts and seals for damage and wear.
- Check the condition of the sweeping brushes. Remove any string, banding, plastic wrap, or other debris wrapped around them.
- Check the sweeping brush patterns for adjustment.
- Check the condition of the hopper dust filter and seals. Clean as required.
- Check the brakes and steering for proper operation.
- Empty the debris hopper.
- Check the service records to determine maintenance requirements.

OPERATION

STARTING THE MACHINE

1. Sit in the operator's seat and engage the brakes with the directional pedal in neutral.

FOR SAFETY: When starting machine, keep foot on brake and directional pedal in neutral.

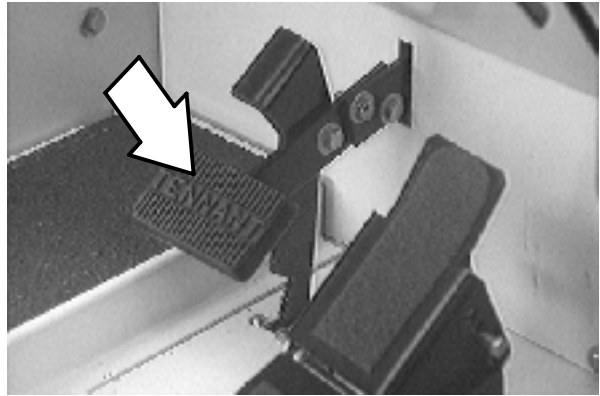

2. Turn the machine power on.

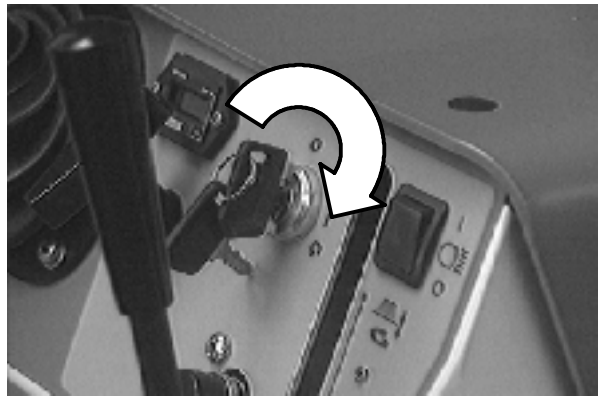

3. Release the machine parking brake.

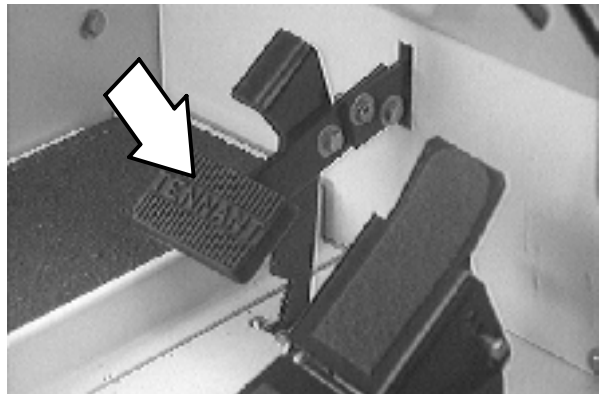

4. Drive the machine to the area to be cleaned.

SWEEPING AND BRUSH INFORMATION

Pick up oversized debris before sweeping. Flatten or remove bulky cartons from aisles before sweeping. Pick up pieces of wire, twine, string, etc., which could become entangled in the brush or brush plugs.

NOTE: Debris can be placed in the hopper through the hopper access door on the front of the hopper.

Plan the sweeping in advance. Try to arrange long runs with minimum stopping and starting. Sweep debris from very narrow aisles into the main aisles ahead of time. Do an entire floor or section at one time. Drive the straightest path possible. Avoid bumping into posts or scraping the sides of the machine. Overlap the brush paths.

Avoid turning the steering wheel too sharply when the machine is in motion. The machine is very responsive to the movement of the steering wheel. Avoid sudden turns, except in emergencies.

For best results, use the correct brush type for your sweeping application. The following are recommendations for main sweeping and side brush applications.

Polypropylene 8-double row main brush – Superior pick-up of sand, gravel, and paper litter. Polypropylene retains its stiffness when wet and can be used indoors or outdoors with equal performance. Not recommended for high-temperature debris.

Polypropylene and wire 8-double row main brush – The wire bristles loosen slightly packed soilage and heavier debris. The polypropylene bristles sweep up the debris with excellent hopper loading.

Polyester 8-double row main brush – Polyester combines the durability of nylon with the moisture resistance of polypropylene.

Polyester 24-single row main brush – Polyester combines the durability of nylon with the moisture resistance of polypropylene. This high density brush is recommended for applications that sweep heavy accumulations of fine dust, sand or other similar material.

Natural Fiber 8-double row main brush – The natural choice for cleaning fine debris on carpet and sweeping very heavy dust and other fine particles on hard surfaces.

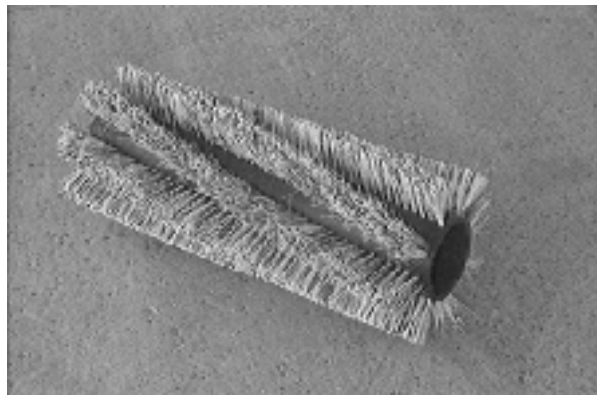

OPERATION

Polypropylene Side Brush - A good general purpose brush for sweeping of light to medium debris in both indoor and outdoor applications. This brush is recommended when bristles may get wet.

Nylon Side Brush - A longer life, general purpose brush that is recommended for rough surfaces.

Flat Wire Side Brush - Recommended for outside and curb-side sweeping where soilage is heavy or compacted. The stiff wire bristles dig out soilage. This brush is also recommended for foundry sweeping where heat may melt synthetic bristles.



SWEEPING

1. Push the hopper door lever forward into the **Hopper door open** position to open the hopper door.

NOTE: If the machine is equipped with the hopper door closed light option, the light will be off when the hopper door is open.



2. Move the vacuum and filter shaker lever to the **Vacuum fan on** position.

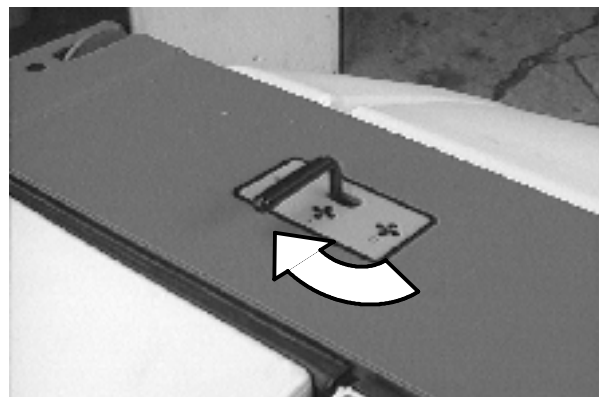

3. Lower and start the main brush with the main brush lever.



4. Lower and start the side brush with the side brush lever.



5. Sweep as needed.

STOP SWEEPING

1. Raise and stop the side brush with the side brush lever.



2. Raise and stop the main brush with the main brush lever.



3. Shake the dust filter by holding the vacuum and filter shaker lever in the **Filter shaker** position for 30 seconds.

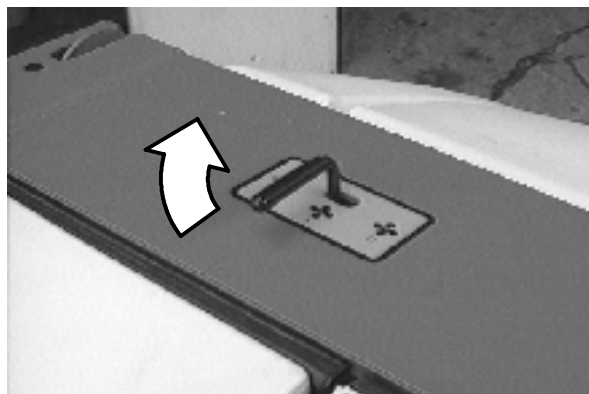

EMPTYING THE HOPPER

1. Stop sweeping.
2. Pull and hold the hopper door lever back into the **Hopper door close** position until the hopper door is closed. Then release the hopper door lever.

NOTE: If the machine is equipped with the hopper door closed light option, the light will come on when the hopper door is closed.

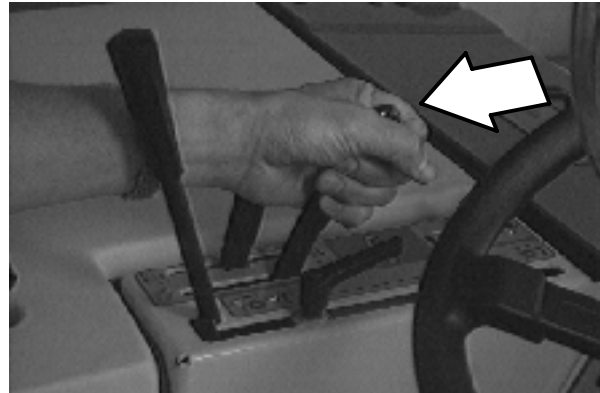

3. Slowly drive the machine to the debris site or debris container.
4. Pull and hold the hopper lever back into the **Hopper up** position to raise the hopper to the desired height. Release the hopper lever into the **Hold** position.

FOR SAFETY: When using machine, make sure adequate clearance is available before raising hopper.

NOTE: Be aware that the minimum ceiling height needed to high dump the hopper is 2340 mm (92 in).

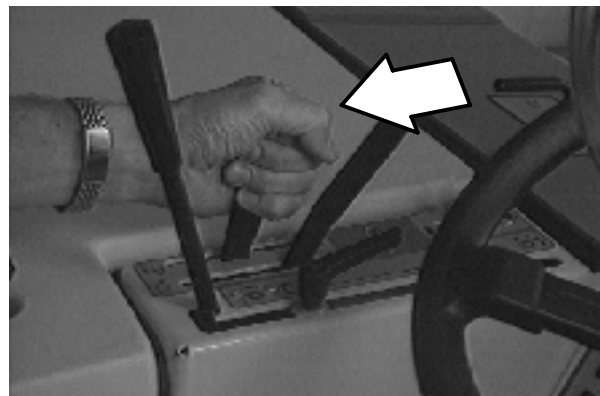

FOR SAFETY: When using machine, move machine with care if hopper is raised.

5. Drive the machine up to the debris container. Position the hopper over the debris container.
6. Move the vacuum and filter shaker lever into the **Vacuum fan off** position.

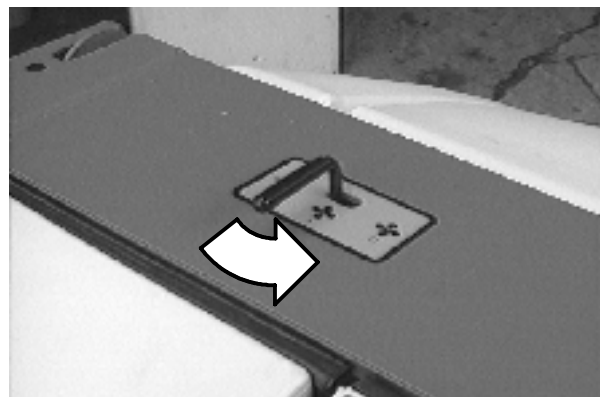

OPERATION

7. Push the hopper door lever forward into the **Hopper door open** position to open the hopper door.

NOTE: If the machine is equipped with the hopper door closed light option, the light will be off when the hopper door is open.

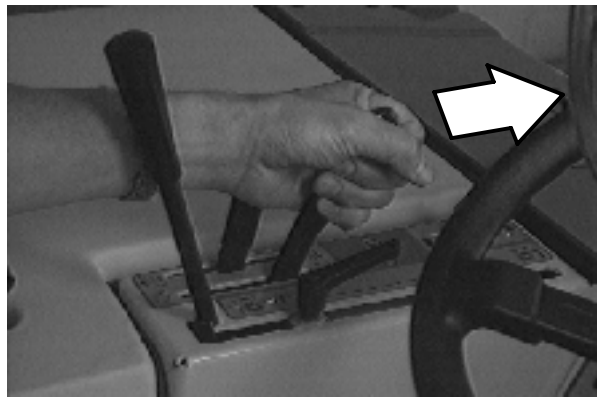

8. Pull the hopper door lever back into the **Hopper door close** position to close the hopper door after the hopper is empty.

NOTE: If the machine is equipped with the hopper door closed light option, the light will come on when the hopper door is closed.

9. Slowly back the machine away from the debris site or debris container.

FOR SAFETY: When using machine, use care when reversing machine.

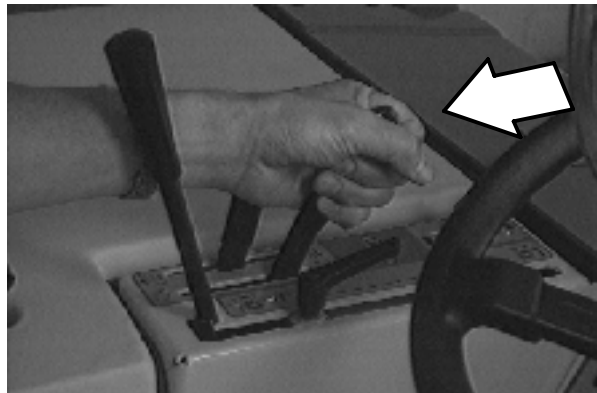

10. Push and hold the hopper lever forward into the **Hopper down** position to lower the hopper. Release the hopper lever into the **Hold** position.

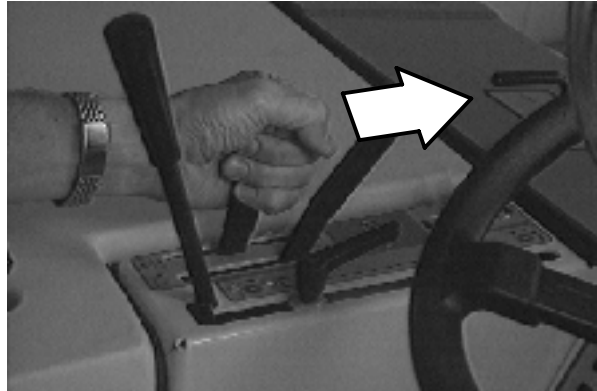

11. Push the hopper door lever forward into the **Hopper door open** position to open the hopper door.

NOTE: If the machine is equipped with the hopper door closed light option, the light will be off when the hopper door is open.



12. Move the vacuum and filter shaker lever into the **Vacuum fan on** position.

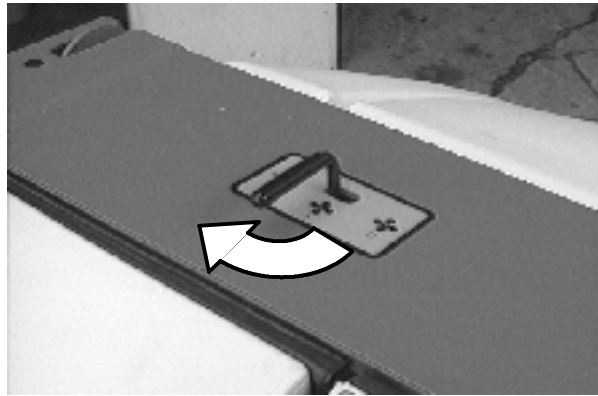

STOP THE MACHINE

1. Stop sweeping.
2. Take your foot off the directional pedal. Step on the brake pedal.

NOTE: The machine will coast for a short distance when your foot is removed from the directional pedal. Use the brake pedal to stop the machine.

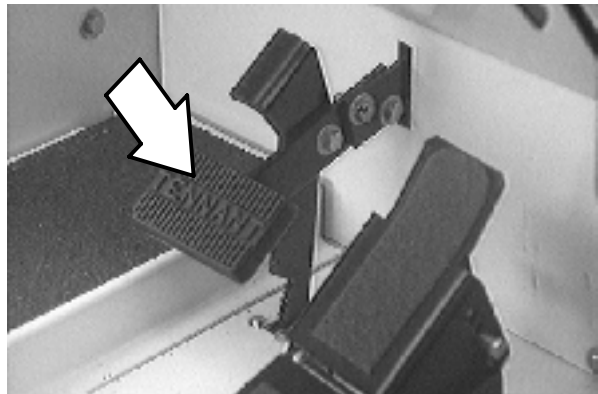

3. Set the machine parking brake.

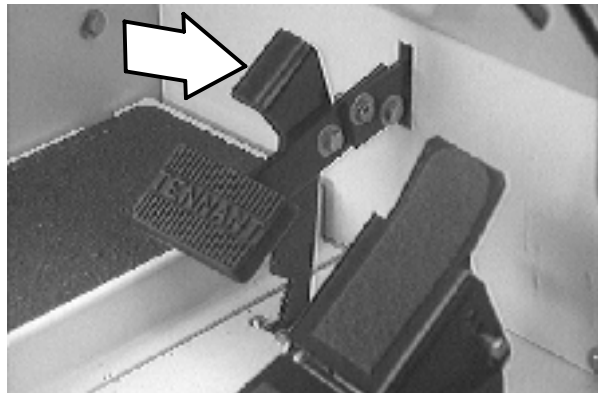

4. Turn the machine power off. Remove the switch key.

FOR SAFETY: Before leaving or servicing machine, stop on level surface, set parking brake, turn off machine, and remove key.

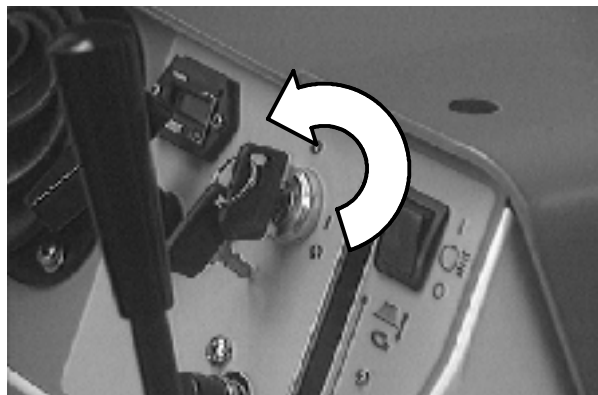

POST-OPERATION CHECKLIST

- Check the hydraulic fluid level. (if applicable)
- Check the battery fluid and charge level.
- Check the skirts and seals for damage and wear.
- Check the condition of the sweeping brushes. Remove any string, banding, plastic wrap, or other debris wrapped around them.
- Check the sweeping brush patterns for adjustment.
- Check the condition of the hopper dust filter and seals. Clean as required.
- Check the brakes and steering for proper operation.
- Empty the debris hopper.
- Check the service records to determine maintenance requirements.

ENGAGING HOPPER SUPPORT BAR

1. Set the machine parking brake.

FOR SAFETY: When starting machine, keep foot on brake and directional pedal in neutral.

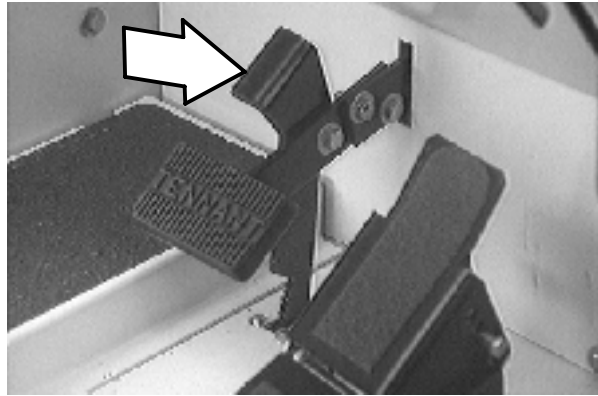

2. Turn the machine power on.

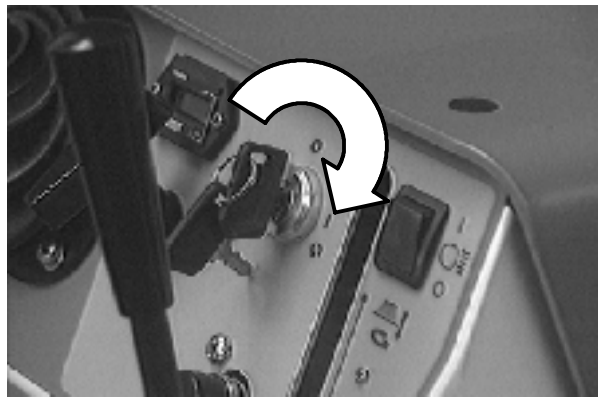

3. Pull and hold the hopper lever back into the **Hopper up** position to raise the hopper. Release the hopper lever into the **Hold** position.

FOR SAFETY: When using machine, make sure adequate clearance is available before raising hopper.

NOTE: Be aware that the minimum ceiling height needed to high dump the hopper is 2340 mm (92 in).

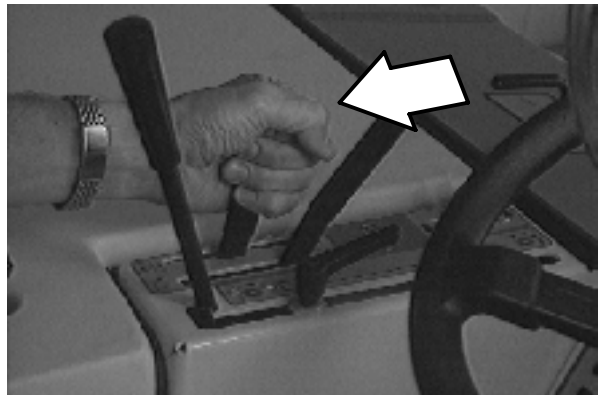

4. Lower and position the hopper support bar onto the support bar stop.

⚠ WARNING: Raised hopper may fall. Engage hopper support bar.



OPERATION

5. Slowly lower the hopper so the hopper support bar rests on the support bar stop.

 **WARNING: Lift arm pinch point. Stay clear of hopper lift arms.**

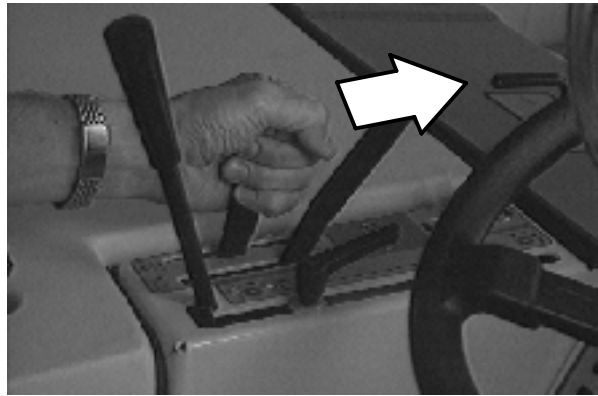

6. Turn the machine power off.

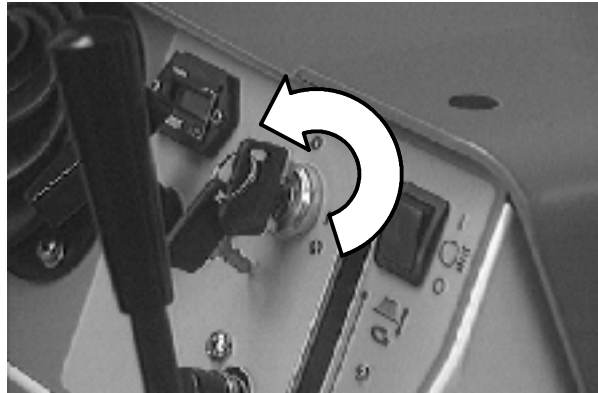

DISENGAGING HOPPER SUPPORT BAR

1. Turn the machine power on.

FOR SAFETY: When starting machine, keep foot on brake and directional pedal in neutral.

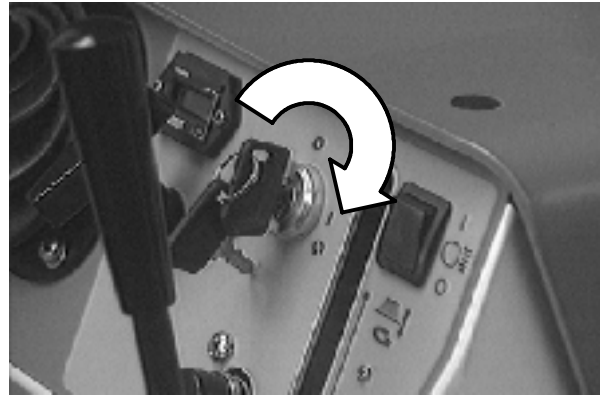

2. Pull and hold the hopper lever back into the **Hopper up** position to raise the hopper slightly.

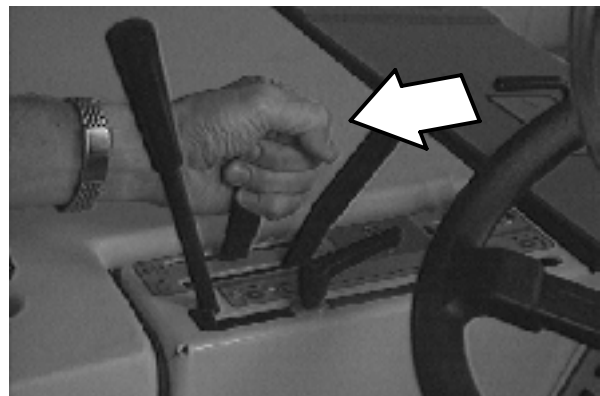

3. Put the support bar in its storage position.



WARNING: Lift arm pinch point. Stay clear of hopper lift arms.



OPERATION

4. Lower the hopper.

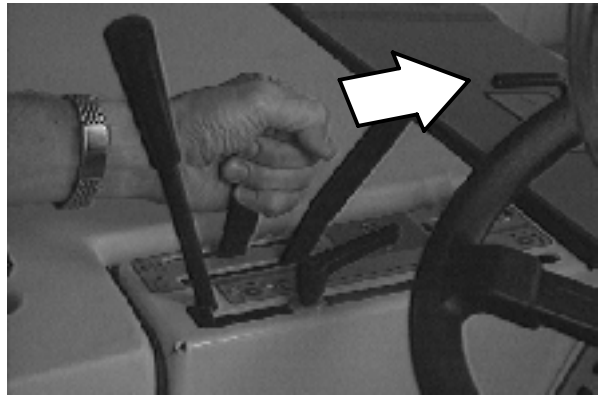

5. Turn the machine power off.

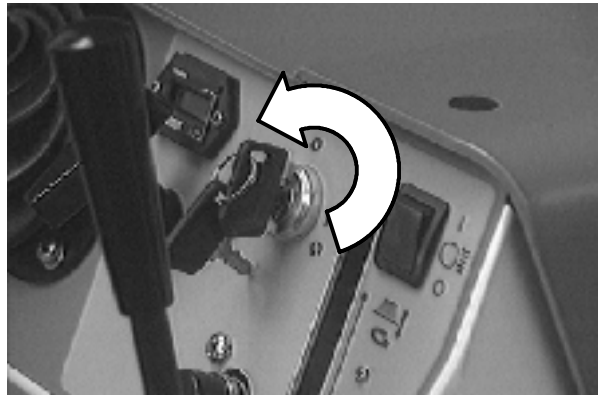

OPERATION ON INCLINES

Drive the machine slowly on inclines. Use the brake pedal to control machine speed when descending inclines.

The maximum rated incline is 8° or 14.1% with a full hopper and 10° or 17.6% with an empty hopper.

FOR SAFETY: When using machine, go slowly on inclines and slippery surfaces.

OPTIONS

VACUUM WAND

The vacuum wand uses the machine's vacuum system. The vacuum hose and wand allow pick-up of debris that is out of reach of the machine.

1. Stop the machine within reach of the area to be vacuumed.
2. Set the machine parking brake and turn the machine power off.
3. Remove the vacuum wand and hose from the mounting clips.



4. Connect the vacuum hose to the vacuum wand.
5. Remove the plug from the side of the hopper.



6. Connect the other end of the vacuum hose to the hopper hose connector.



7. Turn the machine power on.

OPERATION

8. Pull and hold the hopper door lever back into the **Hopper door close** position until the hopper door is closed.

NOTE: If the machine is equipped with the hopper door closed light option, the light will come on when the hopper door is closed.

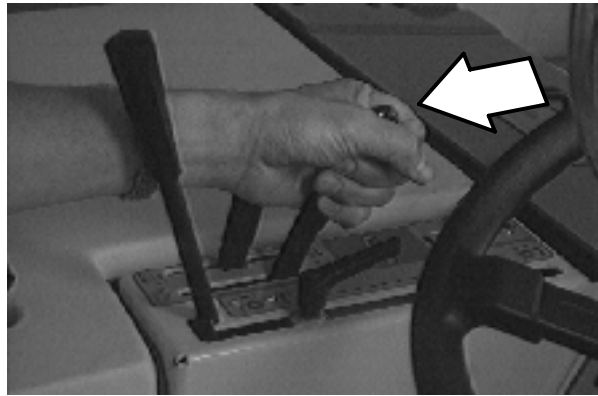

9. Move the vacuum and filter shaker lever into the **Vacuum fan on** position.
10. Vacuum the area as needed.
11. When finished, push the hopper door lever forward into the **Hopper door open** position to open the hopper door.
12. Turn the machine power off.
13. Remove the vacuum hose from the hopper connection.
14. Replace the plug in the side of the hopper.
15. Disconnect the vacuum hose from the vacuum wand.
16. Put the vacuum wand and hose in the mounting clips.

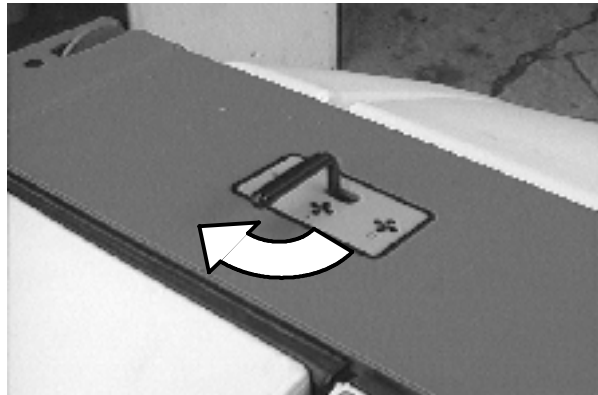

MACHINE TROUBLESHOOTING

Problem	Cause	Remedy
Excessive dusting	Vacuum fan off	Move vacuum and filter shaker lever to Vacuum fan on position
	Brush skirts and dust seals worn, damaged, out of adjustment	Replace or adjust brush skirts or dust seals
	Hopper dust filter clogged	Shake and/or clean or replace dust filter
	Vacuum hose damaged	Replace vacuum hose
	Vacuum fan failure	Contact Tennant service personnel
	Thermo Sentry tripped	Reset Thermo Sentry
	Hopper door partially or completely closed	Open hopper door
Poor sweeping performance	Brush bristles worn	Replace brushes
	Main and side brushes not adjusted properly	Adjust main and side brushes
	Debris caught in main brush drive mechanism	Remove debris from drive mechanism
	Main brush drive failure	Contact Tennant service personnel
	Side brush drive failure	Contact Tennant service personnel
	Hopper full	Empty hopper
	Hopper lip skirts worn or damaged	Replace lip skirts
	Hopper door partially or completely closed	Open the hopper door
	Wrong sweeping brush	Contact Tennant representative for recommendations
	Recirculation flap damaged	Replace flap

MAINTENANCE

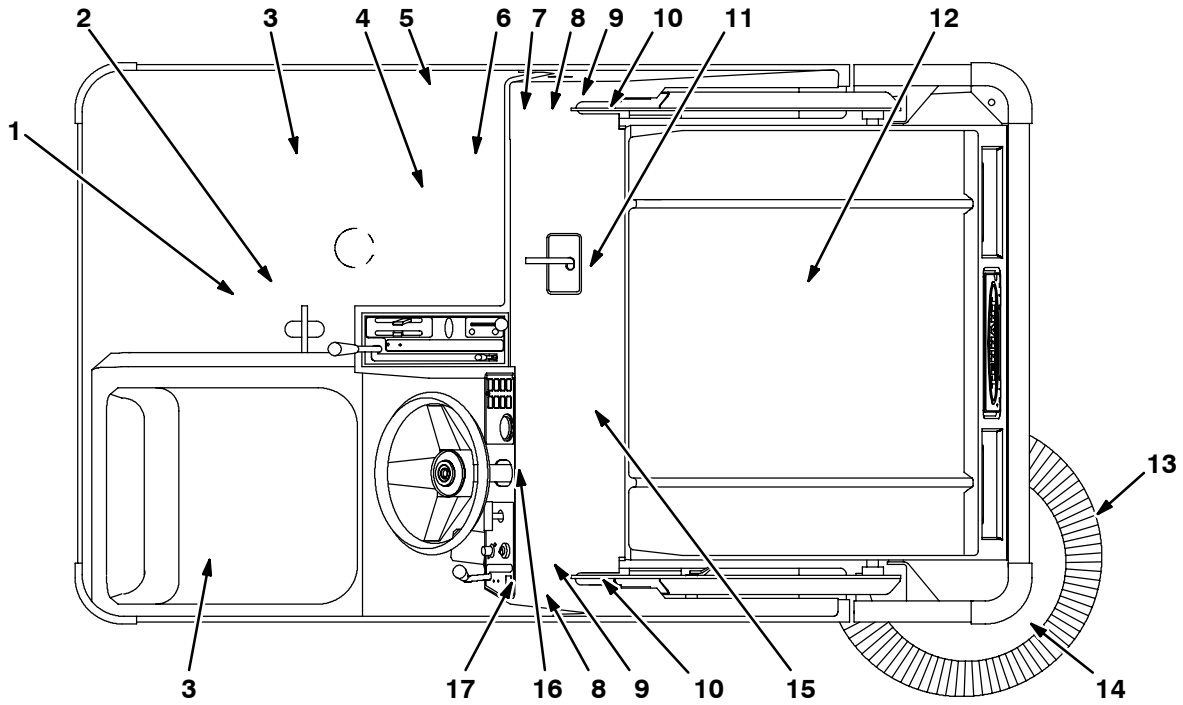

350158

MAINTENANCE CHART

NOTE: Check procedures indicated (■) after the first 50 hours of operation.

Interval	Key	Description	Procedure	Lubricant/ Fluid	No. of Service Points
Daily	8	Brush compartment skirts	Check for damage, wear, and adjustment	-	5
	15	Hopper lip skirts	Check for damage, wear, and adjustment	-	3
	11	Main brush	Check for damage or wear	-	1
			Check brush pattern	-	1
	13	Side brush	Check for damage or wear	-	1
			Check brush pattern	-	1
12	Hopper dust filter	Shake	-	1	
50 Hours	11	Main brush	Rotate end-for-end	-	1
	3	Batteries	Check electrolyte level	DW	6 (2)

Interval	Key	Description	Procedure	Lubricant/ Fluid	No. of Service Points
100 Hours	12	Hopper dust filter	Check for damage, clean or replace	-	1
	4	Hydraulic fluid reservoir	Check fluid level	HYDO	1
	9	Tires	Check for damage	-	3
	1	Propelling gearbox	Check lubricant level	-	1
	8	Main brush and hopper seals	Check for damage or wear	-	8
200 Hours	1	Rear wheel support bearings	Lubricate	SPL	1
	16	Brakes	Check and adjust travel	-	1
	2	Steering link	Lubricate	SPL	1
	10	Hopper lift arm pivots	Lubricate	SPL	2
	14	Side brush pivot	Check adjustment	-	1
	14	Side brush guard	Rotate 90°	-	1
	5	Vacuum fan belt	Check tension and wear	-	1
	5	Hydraulic pump belt	Check tension and wear	-	1
	5	Main brush intermediate belt	Check tension and wear	-	1
5	Main brush belt	Check for wear	-	1	
400 Hours	9	Front wheel bearings	Check for seal damage	-	2
800 Hours	4	Hydraulic fluid reservoir	Replace filler cap	-	1
			Replace suction strainer	-	1
			Change hydraulic fluid	HYDO	1
	6	Hydraulic fluid filter	Change filter element	-	1
	-	Hydraulic hoses	Check for wear and damage	-	All
	1	Propelling gearbox	■Change gear lubricant	GL	1
			■Change fill-level plug seals	-	1
	1	Rear wheel	■Torque wheel nuts	-	1
1, 7	Electric motors	Check carbon brushes	-	2	

LUBRICANT/FLUID

DW . . . Distilled water

GL . . . SAE 90 Gear lubricant

HYDO . Tennant or approved hydraulic fluid

SPL . . . Special lubricant, Lubriplate EMB grease (TENNANT part no. 01433-1)

NOTE: More frequent intervals may be required in extremely dusty conditions.

LUBRICATION

PROPELLING GEARBOX

Check the lubricant level in the propelling gearbox after every 100 hours of operation. Change the gear lubricant, and the drain and fill-level plug seals after the first 50 hours of operation, and then after every 800 hours of operation. Use SAE 90 weight gear lubricant.

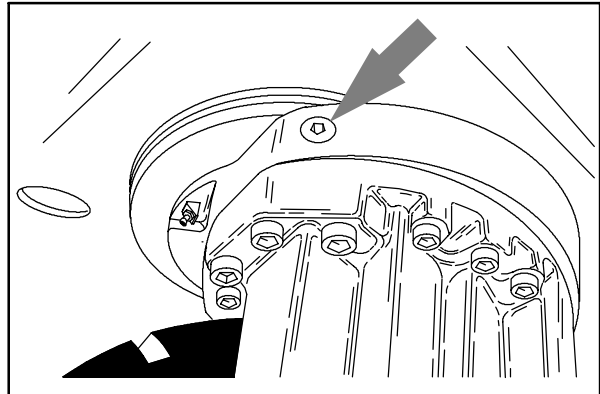

05934

REAR WHEEL SUPPORT

The rear wheel support pivots the rear wheel to steer the machine. The support has two grease fittings for the bearings. Raise the machine so the rear wheel support assembly is off the floor. Fill one of the grease fittings while rotating the gearbox from stop to stop. Fill the second grease fitting while rotating the gearbox back to the original position. The bearing cavity is full when grease comes out of the top seal.

Lubricate with Lubriplate EMB grease (Tennant part number 01433-1) after every 200 hours of machine operation, or after steam cleaning the gearbox area.

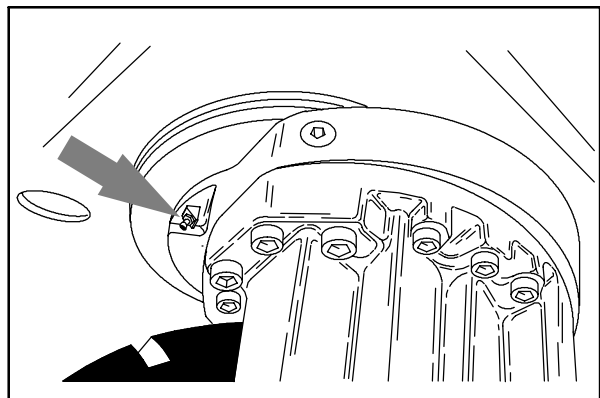

05934

FOR SAFETY: When servicing machine, block machine tires before jacking up machine.

FOR SAFETY: When servicing machine, jack up machine at designated locations only. Block machine up with jack stands.

STEERING LINK

The steering link has one grease fitting located on the end of the link.

Lubricate with Lubriplate EMB grease (Tennant part number 01433-1) after every 200 hours of machine operation.

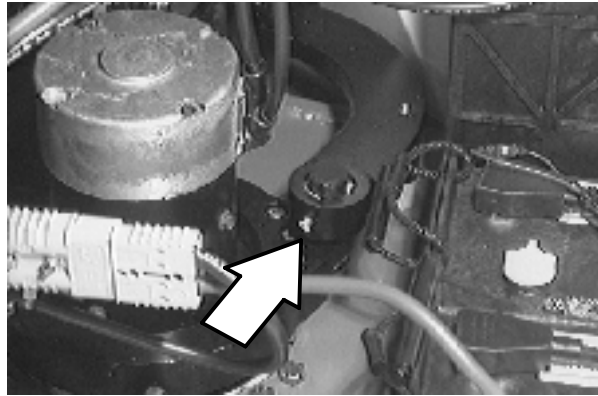
**FRONT WHEEL BEARINGS**

Inspect the front wheel bearings for seal damage after every 400 hours of operation. Replace bearings when necessary.

**HOPPER LIFT ARM PIVOTS**

The hopper lift arms have two grease fittings, one on each lift arm.

Lubricate with Lubriplate EMB grease (Tennant part number 01433-1) after every 200 hours of machine operation.



HYDRAULICS

HYDRAULIC FLUID RESERVOIR

The reservoir is located in front of the batteries next to the vacuum fan.

A filler cap is mounted on top of the reservoir. It has a built-in breather and fluid level dipstick. Replace the cap after every 800 hours of operation.

Check the hydraulic fluid level at operating temperature after every 100 hours of operation. Make sure the hopper is down when checking hydraulic fluid level. The end of the dipstick is marked with FULL and ADD levels to indicate the level of hydraulic fluid in the reservoir.

Lubricate the filler cap gasket with a film of hydraulic fluid before putting the cap back on the reservoir.

ATTENTION! Do not overfill the hydraulic fluid reservoir or operate the machine with a low level of hydraulic fluid in the reservoir. Damage to the machine hydraulic system may result.

Drain and refill the hydraulic fluid reservoir with new hydraulic fluid after every 800 hours of operation.

The hydraulic fluid filter is located in front of the hydraulic reservoir. Replace the filter element after every 800 hours of operation.

NOTE: If the machine is equipped with the hydraulic filter bypass light option, and the light comes on, replace the filter as soon as possible.

The reservoir has a built-in strainer outlet that filters hydraulic fluid before it enters the system. Replace the strainer after every 800 hours of operation.

HYDRAULIC FLUID

The quality and condition of the hydraulic fluid play a very important role in how well the machine operates. Tennant's hydraulic fluid is specially selected to meet the needs of Tennant machines.

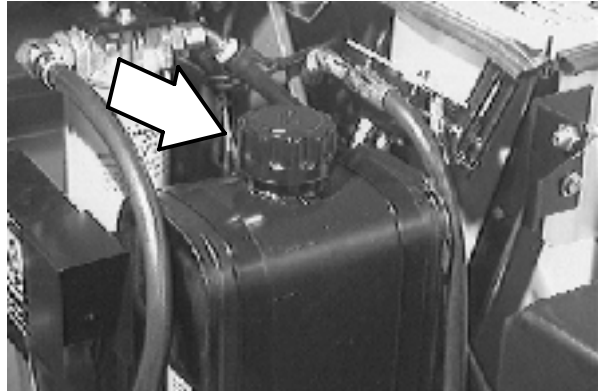

Tennant's hydraulic fluids provide a longer life for the hydraulic components. There is one recommended fluid.

Tennant hydraulic fluid	
Part number	Fluid weight
65870	SHP 5/20

If a locally available hydraulic fluid is used, make sure the specifications match Tennant hydraulic fluid specifications. Using substitute fluids can cause premature failure of hydraulic components.

ATTENTION! Hydraulic components depend on system hydraulic fluid for internal lubrication. Malfunctions, accelerated wear, and damage will result if dirt or other contaminants enter the hydraulic system.

HYDRAULIC HOSES

Check the hydraulic hoses after every 800 hours of operation for wear or damage.

Fluid escaping at high pressure from a very small hole can be almost invisible, and can cause serious injuries.

See a doctor at once if injury results from escaping hydraulic fluid. Serious infection or reaction can develop if proper medical treatment is not given immediately.

FOR SAFETY: When servicing machine, use cardboard to locate leaking hydraulic fluid under pressure.

If you discover a fluid leak, contact your mechanic or supervisor.

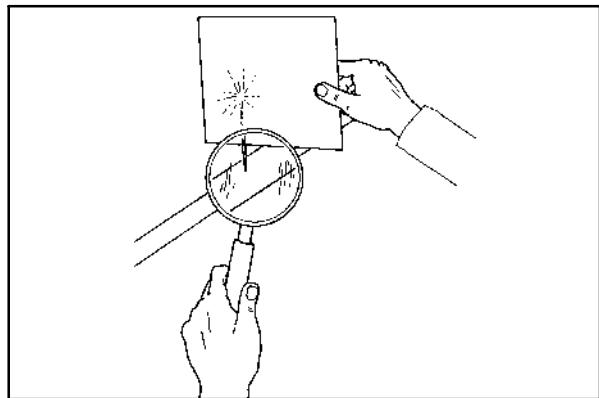

00002

BATTERIES

The batteries are unique in that they hold their power for long periods of time. The lifetime of the batteries is limited by the number of charges the batteries receive. To get the most life from the batteries, charge them when the last battery discharge indicator segment flashes (20% charge left). Use an automatic charger with the proper rating for the batteries.

Periodically clean the top surface of the batteries and the terminals, and check for loose connections. Use a strong solution of baking soda and water. Brush the solution sparingly over the battery tops, terminals, and cable clamps. Do not allow any baking soda solution to enter the batteries. Use a wire brush to clean the terminal posts and the cable connectors. After cleaning, apply a coating of clear battery post protectant to the terminals and the cable connectors. Keep the tops of the batteries clean and dry.

Keep all metallic objects off the top of the batteries, which may cause a short circuit. Replace any worn or damaged wires.

Check the electrolyte level in each battery cell before and after charging, and after every 50 hours of operation. Do not charge the batteries unless the fluid is slightly above the battery plates. If needed, add just enough distilled water to cover the plates. Never add acid to the batteries. Do not overfill. Always keep the battery caps on, except when adding water or taking hydrometer readings.

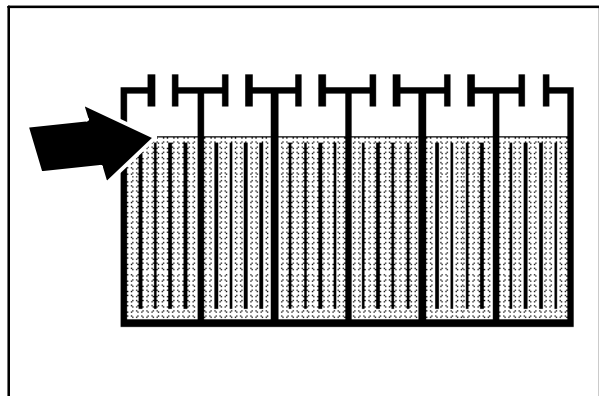

Measuring the specific gravity, using a hydrometer, is a way to determine the charge level and condition of the batteries. If one or more of the battery cells test lower than the other battery cells (0.050 or more), the cell is damaged, shorted, or is about to fail.

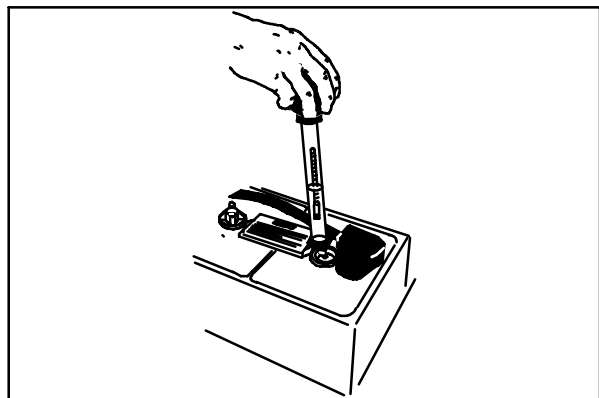

04380

NOTE: Do not take readings immediately after adding distilled water. If the water and acid are not thoroughly mixed, the readings may not be accurate. Check the hydrometer readings against the following chart to determine the remaining battery charge level:

SPECIFIC GRAVITY at 25° C (77° F)			
Charge Level	315A/hr Battery	340A/hr Battery	440A/hr Battery
100%	1.290	1.300	1.315
20%	1.250	1.155	1.155
0%	1.140	1.120	1.115

NOTE: If the readings are taken when the battery electrolyte is any temperature other than shown, the reading must be temperature corrected. Add or subtract to the specific gravity reading 0.004, 4 points, for each 6° C (10° F) above or below 25° C (77° F).

CHARGING THE BATTERIES

1. Drive the machine to a flat, dry surface in a well-ventilated area.
2. Stop the machine, set the parking brake and turn the machine power off.

FOR SAFETY: Before leaving or servicing machine, stop on level surface, set parking brake, turn off machine, and remove key.

3. Open the seat support.
4. Check the electrolyte level in all the battery cells.

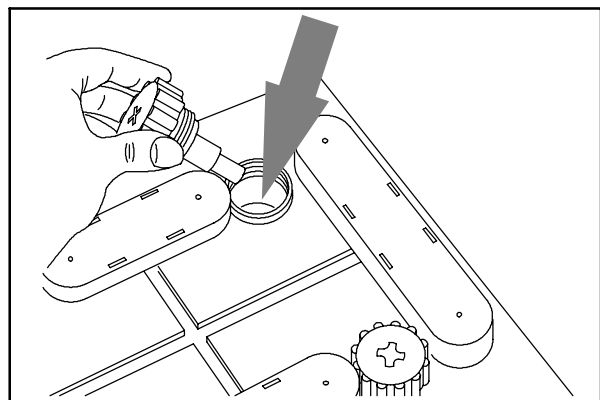

08247

MAINTENANCE

5. If the level is low, add just enough distilled water to cover the battery plates. **DO NOT OVERFILL.** The batteries can overflow during charging due to expansion.

NOTE: Make sure the battery caps are in place while charging.

FOR SAFETY: When maintaining or servicing machine, avoid contact with battery acid.

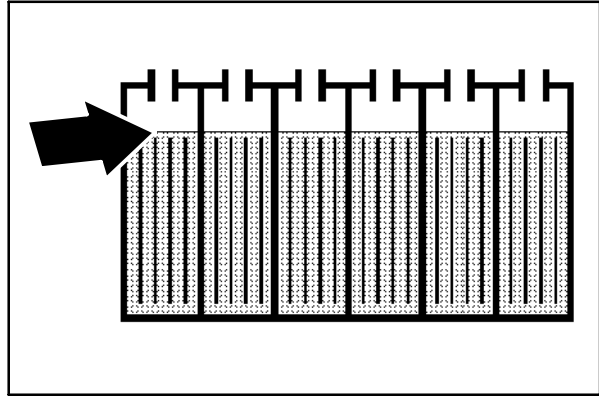

6. Unplug the battery connector from the machine connector.

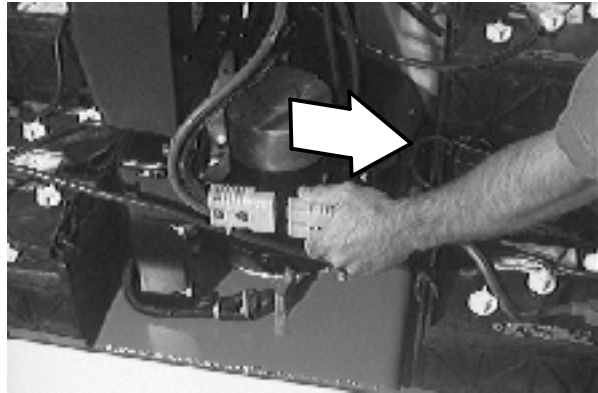

7. Plug the charger connector into the battery connector.

 **WARNING: Batteries emit hydrogen gas. Explosion or fire can result. Keep sparks and open flame away. Keep covers open when charging.**

NOTE: If the red "ABNORMAL CYCLE" lamp lights when the batteries are plugged into the TENNANT charger, this indicates that something is wrong with the battery. The charger can not charge the battery when this happens.

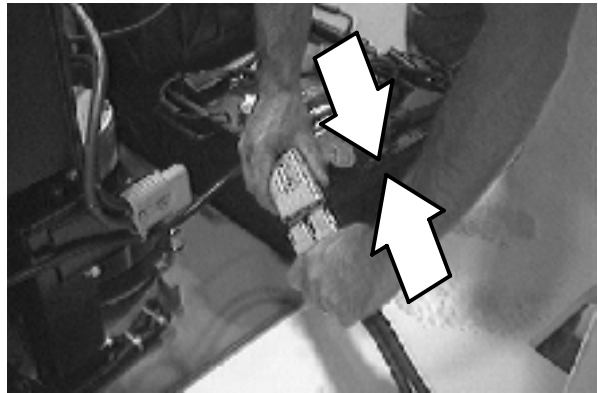

8. The Tennant charger will start automatically. When the batteries are fully charged, the Tennant charger will automatically turn off.

NOTE: Use a charger with the proper rating for the batteries to prevent damage to the batteries or reduce the battery life.

NOTE: If the charger needs to be disconnected from the machine before the batteries are fully charged and the charger has not automatically shut off, turn off the charger before disconnecting it.



9. After the charger has turned off, unplug the charger connector from the battery connector on the machine.

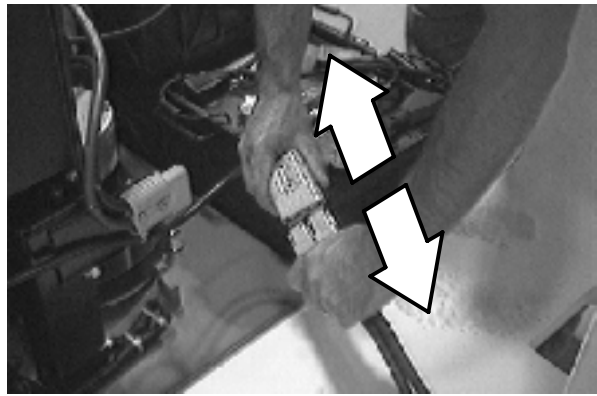

10. Reconnect the battery connector to the machine connector.
11. Check the electrolyte level in each battery cell after charging. If needed, add distilled water to raise the electrolyte level to about 12mm (0.4 in) below the bottom of the sight tubes.

FOR SAFETY: When maintaining or servicing machine, avoid contact with battery acid.

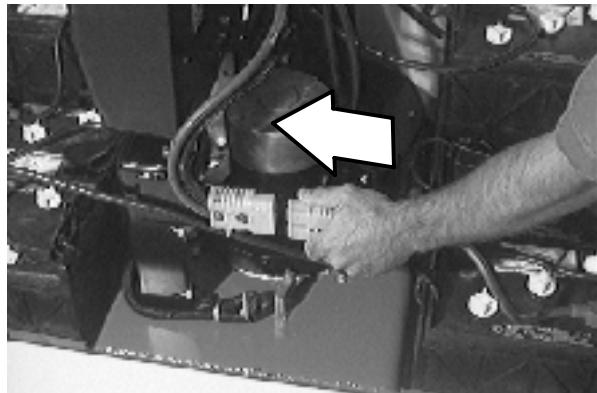

12. Close the seat support.

ELECTRIC MOTORS

The carbon brushes on the propelling and accessories motors should be inspected after every 800 hours of machine operation.

BELTS AND CHAINS

HYDRAULIC PUMP BELT

Check the hydraulic pump belt tension and wear after every 200 hours of operation. The correct tension is when the belt at midpoint deflects 4 mm (0.15 in) from a force of 2.5 kg (5.5 lb).



WARNING: Moving belt and fan. Keep away.

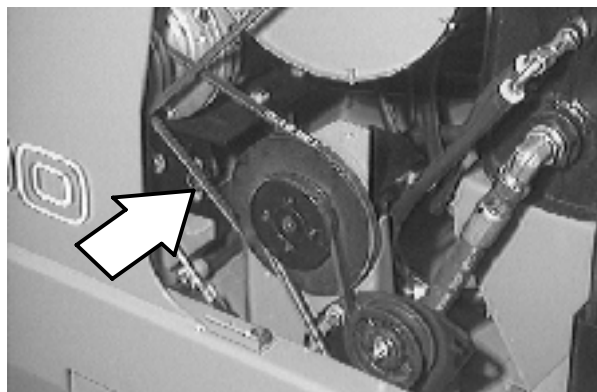

MAINTENANCE

VACUUM FAN BELT

Check the vacuum fan belt tension and wear after every 200 hours of operation. The correct tension is when the belt deflects 5 mm (0.18 in) from a force of 1.4 kg (3 lb) at belt midpoint.

 **WARNING: Moving belt and fan. Keep away.**

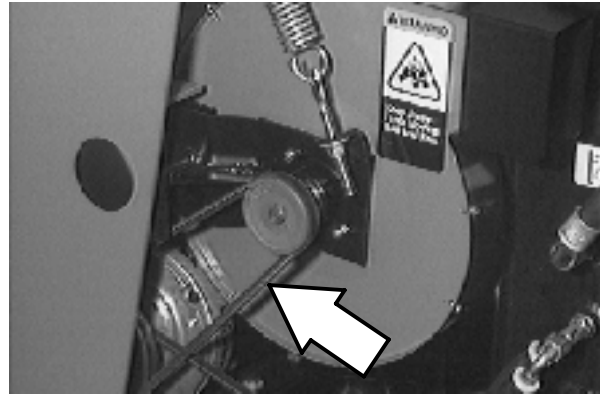

MAIN BRUSH INTERMEDIATE BELT

Check the main brush intermediate belt tension and for wear after every 200 hours of operation. The correct tension is when the belt deflects 8 mm (0.3 in) from a force of 2.3 kg (5 lb) at belt midpoint.

 **WARNING: Moving belt and fan. Keep away.**

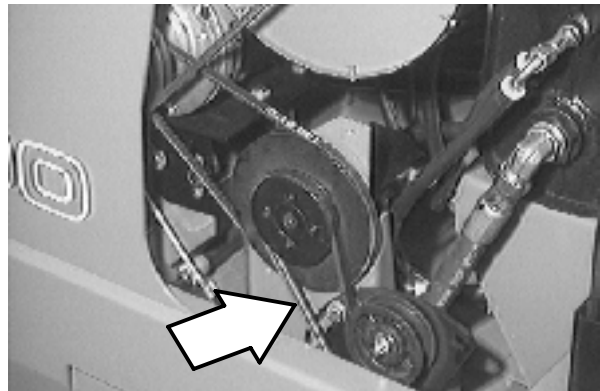

MAIN BRUSH BELT

Check the main brush belt for wear after every 200 hours of operation. The spring idler keeps tension on the belt.

 **WARNING: Moving belt and fan. Keep away.**

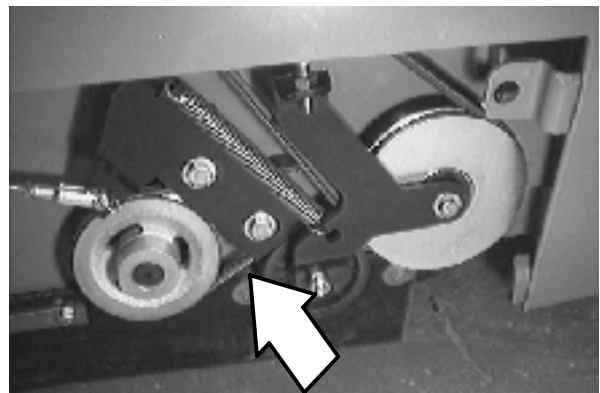

STATIC DRAG CHAIN

A static drag chain prevents the buildup of static electricity in the machine. The chain is attached to the machine by a rear main brush skirt retaining bolt.

Make sure the chain is touching the floor at all times.

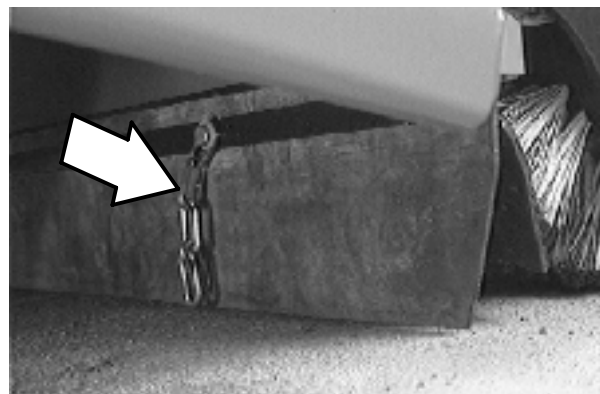

DEBRIS HOPPER

HOPPER DUST FILTER

The dust filter filters the air pulled up from the hopper. The dust filter is equipped with a shaker to remove the accumulated dust particles. The dust filter shaker is operated by the vacuum and filter shaker lever.

The standard dust filter works well for normal sweeping applications. The synthetic filter works well for humid or wet applications.

Shake the dust filter before emptying the hopper and at the end of every work shift. Check and clean or replace the dust filter after every 100 hours of operation.

To clean the dust filter, use one of the following methods:

- **SHAKING** – Move the vacuum and filter shaker lever to the **Filter shaker** position.
- **TAPPING** – Tap the filter gently on a flat surface with the dirty side down. Do not damage the edges of the filter element and seals, or the filter will not seat properly in the filter frame.
- **AIR** – Always wear eye protection when using compressed air. Blow air through the dust filter opposite the direction of the arrows. Never use more than 690 kPa (100 psi) of air pressure and never closer than 50 mm (2 in) away from the filter. This may be done with the dust filter in the machine.

FOR SAFETY: When servicing machine, wear eye and ear protection if using pressurized air or water.

- **WATER** – Rinse the synthetic filter with a low pressure garden hose through the dust filter opposite the direction of the arrows. The standard dust filter can also be rinsed, but the filter will degrade with each rinsing and should be replaced after rinsing five times.

NOTE: Be sure the dust filter is completely dry before reinstalling it in the machine.



MAINTENANCE

REMOVING HOPPER DUST FILTER

1. Stop the machine, set the parking brake and turn the machine power off.

FOR SAFETY: Before leaving or servicing machine, stop on level surface, set parking brake, turn off machine, and remove key.

2. Unlatch and open the hopper cover. Support the hopper with the hopper cover prop rod.

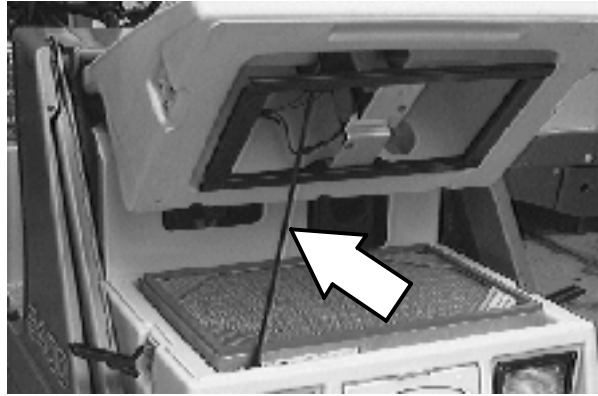

3. Lift the dust filter element out of the hopper insert.



4. Clean or discard the dust filter as required.
5. Clean and inspect the filter sealing surfaces. Make sure the foam element centering strips attached to the hopper and intact. Put the cleaned or new dust filter in the hopper insert with the arrows pointing up.
6. Lower the hopper cover support and close the hopper. Latch the hopper cover.

BRUSHES

MAIN BRUSH

The main brush is cylindrical and spans the width of the machine, sweeping debris into the hopper.

Check the brush daily for wear or damage. Remove any string or wire tangled on the main brush, main brush drive hub, or main brush idler hub.

Check the main brush pattern daily. The pattern should be 50 to 75 mm (2 to 3 in) wide with the main brush in the lowered position. Adjust the main brush pattern by turning the main brush down pressure knob and moving the brush stop.

Rotate the main brush end-for-end after every 50 hours of operation for maximum brush life and best sweeping performance.

Replace the brush when it no longer cleans effectively.

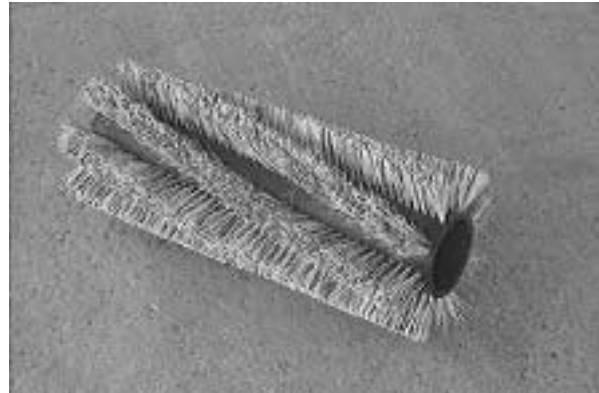

REPLACING MAIN BRUSH

1. Stop the machine, set the parking brake and turn the machine power off.

FOR SAFETY: Before leaving or servicing machine, stop on level surface, set parking brake, turn off machine, and remove key.

2. Lower the main brush.
3. Open the right side main brush access door.
4. Loosen the idler arm mounting T-bolt. Remove the brush idler arm assembly.
5. Grasp the main brush; pull it off the brush drive plug and out of the main brush compartment.
6. Put the new or rotated end-for-end main brush on the floor next to the access door.
7. Slide the main brush onto the drive plug. Rotate the brush until it engages the drive plug, and push it all the way onto the plug.
8. Slide the main brush idler arm plug onto the main brush.



MAINTENANCE

9. Secure the idler arm on the pins. Hand tighten the mounting T-bolt.
10. Close the main brush access door.

CHECKING AND ADJUSTING MAIN BRUSH PATTERN

1. Apply chalk, or some other material that will not blow away easily, to a smooth, level floor.
2. Raise the side brush and main brush and position the main brush over the chalked area.
3. Lower the main brush for 15 to 20 seconds while keeping a foot on the brakes to keep the machine from moving.

NOTE: If chalk or other material is not available, allow the brushes to spin on the floor for two minutes. A polish mark will remain on the floor.

4. Raise the main brush.
5. Drive the machine off the test area.
6. Observe the width of the brush pattern. The proper brush pattern width is 50 to 75 mm (2 to 3 in).

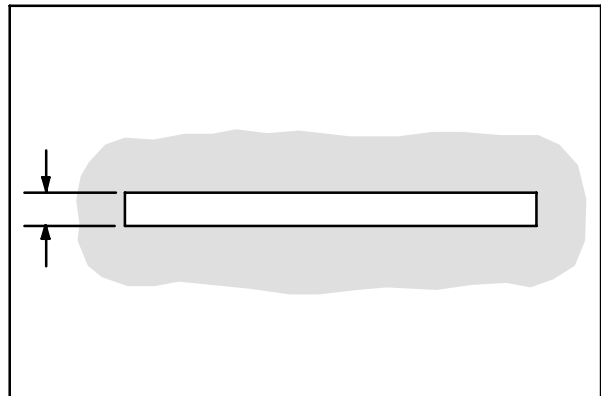
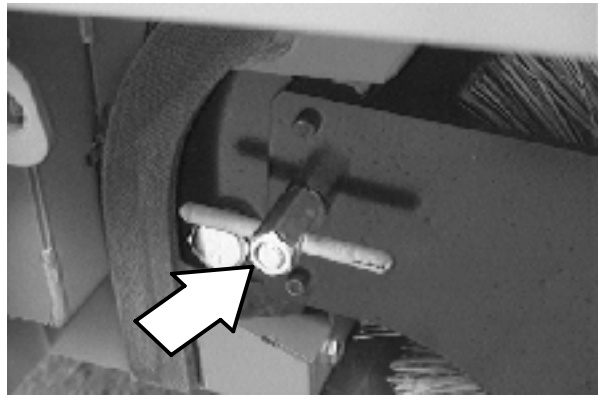

00582

7. To increase the width of the main brush pattern, move the main brush down pressure knob forward, away from the operator.

To decrease the width of the main brush pattern, move the main brush down pressure knob backward, towards the operator.

The brush taper is factory set and should not need adjustment unless parts of the brush system have been replaced.

If the main brush pattern is tapered, more than 15 mm (0.5 in) on one end than the other, adjust the taper as follows:

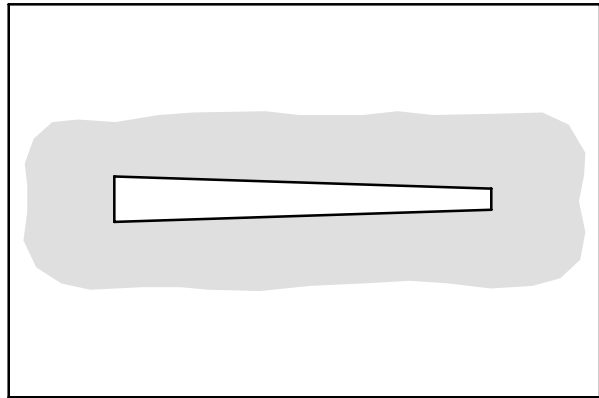
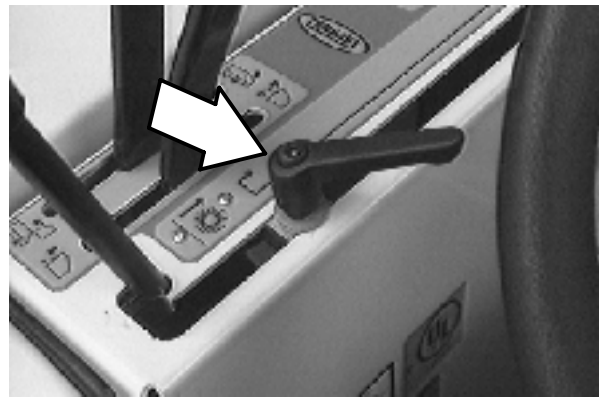

00601

- A. Loosen the brush shaft bearing bracket mounting bolts.

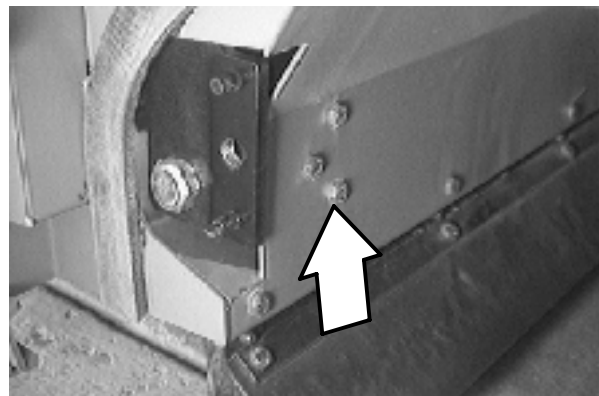

- B. Move the brush shaft bearing bracket up or down in the slots.
- C. Check the main brush pattern and readjust as necessary. Then adjust the width of the main brush pattern.

SIDE BRUSH

The side brush sweeps debris along edges into the path of the main brush.

Check the brush daily for wear or damage. Remove any string or wire found tangled on the side brush or side brush drive hub.

Check the side brush pattern daily. The side brush bristles should contact the floor in a 10 o'clock to 3 o'clock pattern when the brush is in motion. Adjust the side brush pattern by the side brush down pressure knob. Turn the knob counterclockwise to increase the brush contact with the sweeping surface, and clockwise to decrease the brush contact with the sweeping surface.

Replace the brush when it no longer cleans effectively.

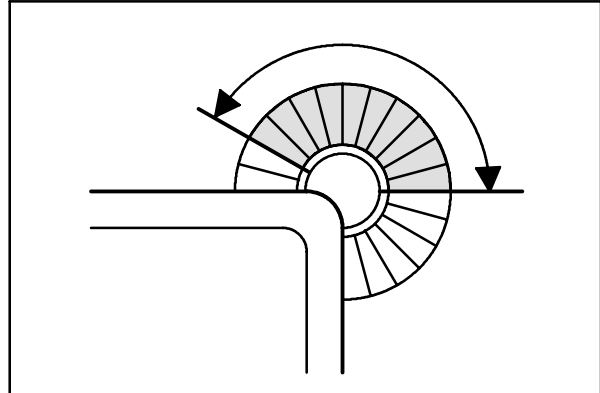

350327

REPLACING SIDE BRUSH

1. Stop the machine, set the parking brake and turn the machine power off.

FOR SAFETY: Before leaving or servicing machine, stop on level surface, set parking brake, turn off machine, and remove key.

2. Remove the side brush retaining pin from the side brush drive shaft by pulling the pin keeper off over the end of the pin.
3. Slide the side brush off the side brush drive shaft.

NOTE: Remove the drive hub and put it on the new brush if one is not installed.

4. Slide the new side brush onto the side brush drive shaft.
5. Insert the side brush retaining pin through the side brush hub and shaft.
6. Secure the pin by clipping the pin keeper over the end of the pin.
7. Adjust the side brush pattern with the side brush down pressure knob.

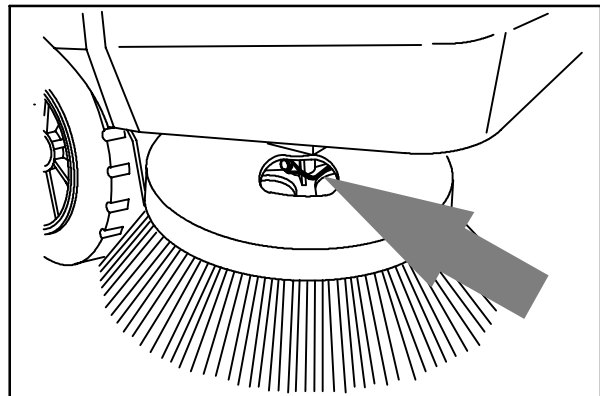

08019

SIDE BRUSH GUARD

Rotate the side brush guard 90° after every 200 hours of operation. Replace the brush guard after using all four sides.

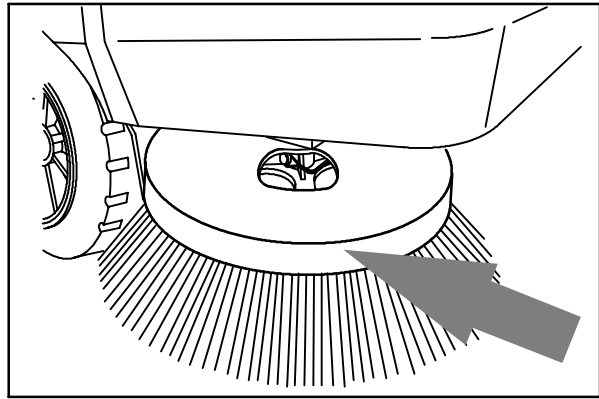

08049

SIDE BRUSH PIVOT

The side brush pivot should be checked for excessive movement after every 200 hours of operation. Torque the front and rear compression springs to reduce excessive movement.

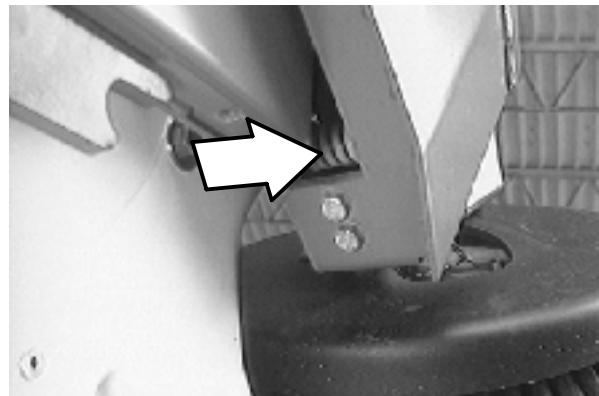
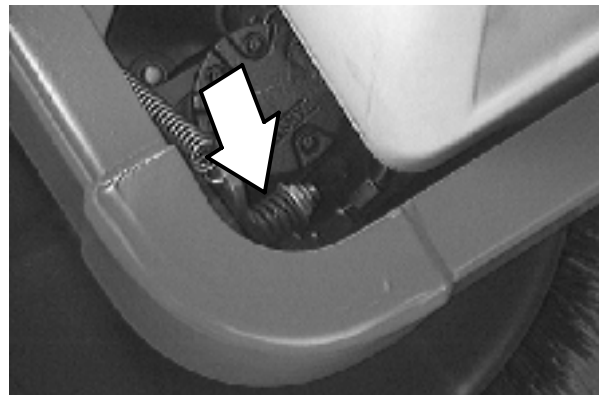

The side brush tilt is adjusted with the side brush cable. Turn the clevis on the cable to get the desired side brush pattern.

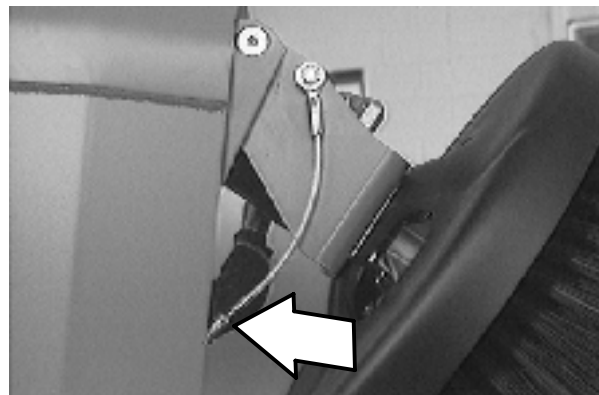

SKIRTS AND SEALS

HOPPER LIP SKIRT

The hopper lip skirt is located on the bottom rear of the hopper. The skirt floats over debris and helps deflect that debris into the hopper.

Check the hopper lip skirts for wear or damage daily.

Replace the hopper lip skirts when it no longer touches the floor.

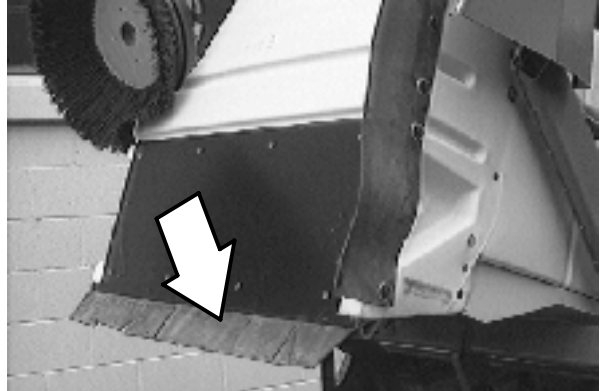

HOPPER SIDE SKIRT

The hopper side skirt is located on the left side of the hopper. The hopper side skirt should clear the floor by 3 mm (0.12 in).

Check the hopper side skirt for wear or damage and adjustment daily.

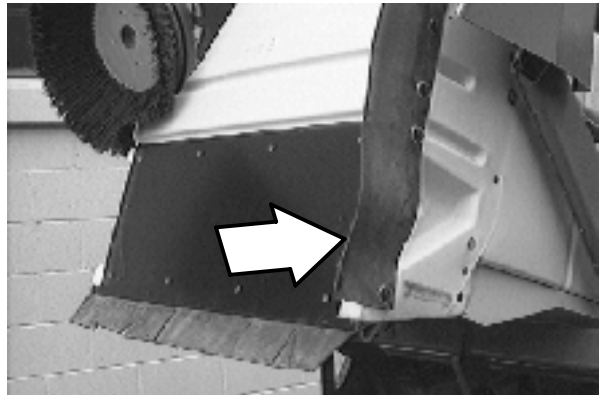

BRUSH DOOR SKIRTS

The brush door skirts are located on the bottom of each of the two main brush doors. The skirt should clear the floor by 3 to 6 mm (0.12 to 0.25 in).

Check the skirts for wear or damage and adjustment daily.

NOTE: The brush door skirts have slotted holes to allow for a ground clearance adjustment. Adjust the skirt height with the door closed.

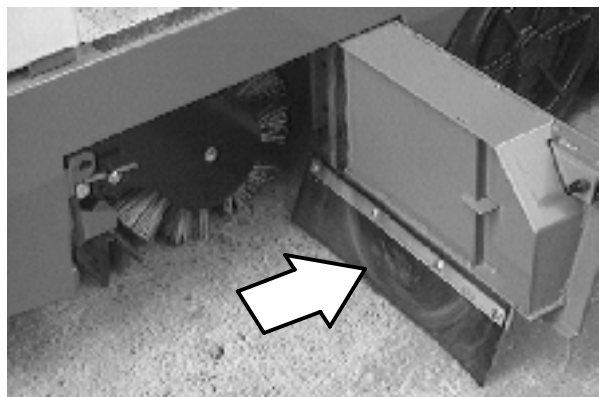

REAR SKIRTS

The two rear skirts are located on the bottom rear of the main brush compartment. The vertical skirt should clear the floor up to 5 mm (0.25 in). The recirculation skirt requires no adjustment.

Check the skirts for wear or damage and adjustment daily.

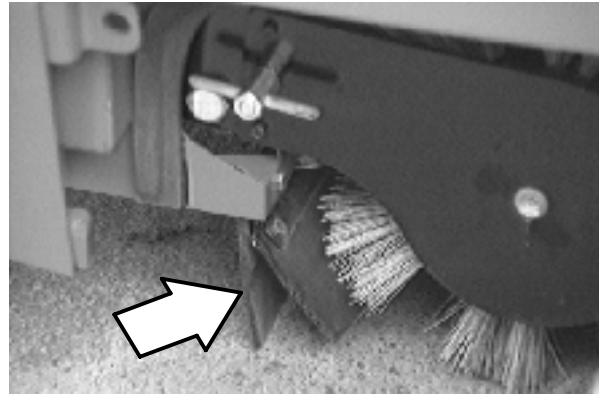

SIDE BRUSH DUST CONTROL SKIRTS (OPTION)

The side brush dust control skirts wrap around the side brush and the front bumper.

Check the side brush dust control skirts for wear or damage daily.

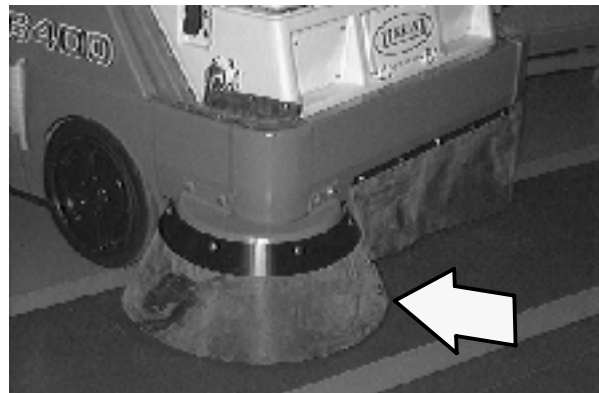

BRUSH DOOR SEALS

The brush door seals are located on both main brush doors and on corresponding portions of the main frame.

Check the seals for wear or damage after every 100 hours of operation.

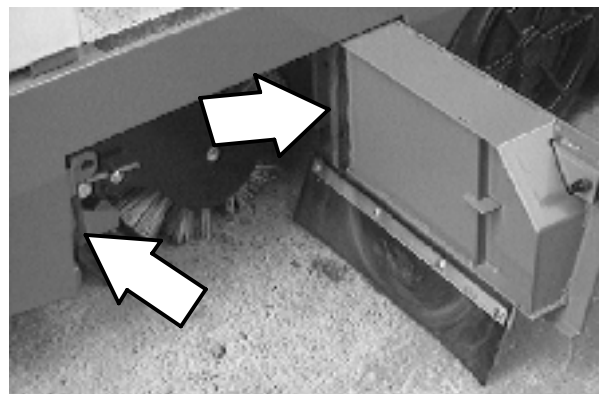

HOPPER SEALS

The hopper seals are located on the top and side portions of the machine frame that contact the hopper.

Check the seals for wear or damage after every 100 hours of operation.



MAINTENANCE

HOPPER ACCESS DOOR SEAL

The hopper access door seal is located on the hopper and seals the front of the debris hopper.

Check the seal for wear or damage after every 100 hours of operation.

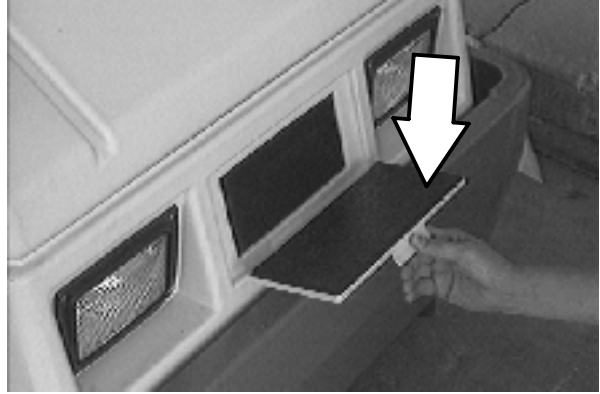

HOPPER DOOR SEALS

The hopper door seals are located on the hopper door. They seal the hopper when the hopper door is closed.

Check the seals for wear or damage after every 100 hours of operation.

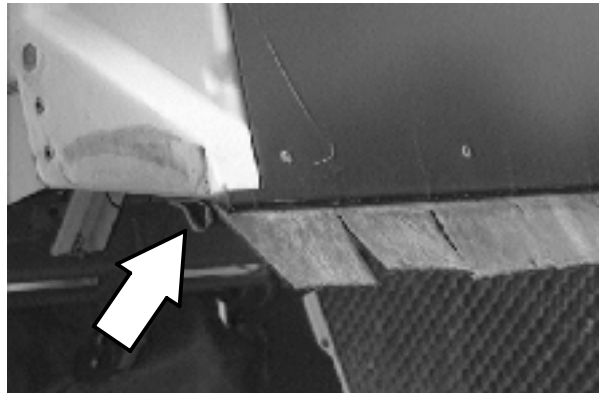

VACUUM FAN SEAL

The vacuum fan seal is mounted on the vacuum shut-off plate.

Check the seal for wear or damage after every 100 hours of operation.

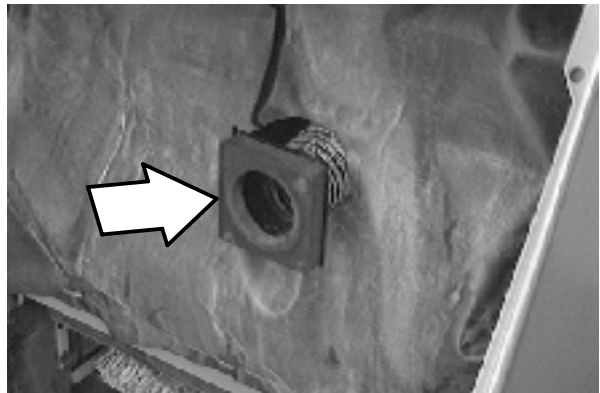

BRAKES AND TIRES

BRAKES

The mechanical brakes are located on the front wheels. The brakes are operated by the foot brake pedal and connecting rods.

Check the brake adjustment after every 200 hours of operation.

TIRES

All the tires on the machine are solid. Check the front tires after every 100 hours of operation for damage.

**REAR WHEEL**

Torque the rear wheel nuts twice in the pattern shown to 122-155 Nm (90-110 ft. lbs) after the first 50 hours of operation, and every 800 hours of operation.

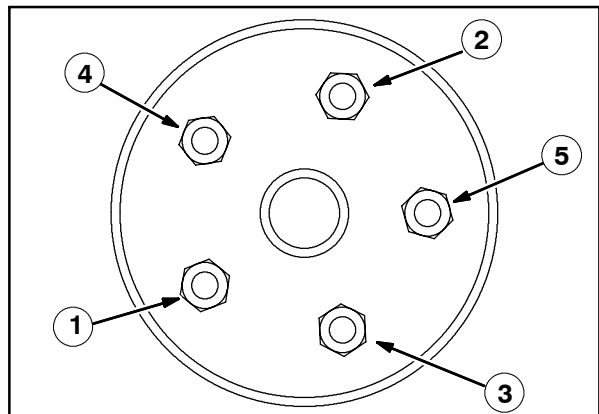

PUSHING, TOWING, AND TRANSPORTING THE MACHINE

PUSHING OR TOWING THE MACHINE

If the machine becomes disabled, it can be pushed from the front or rear, but tow it only from the rear.

Only push or tow the machine for a *very short distance* and do not exceed 3.2 kp/h (2 mph). It is NOT intended to be pushed or towed for a long distance or at a high speed.

ATTENTION! Do not push or tow machine for a long distance or damage may occur to the propelling system.

TRANSPORTING THE MACHINE

1. Position the rear of the machine at the loading edge of the truck or trailer.

FOR SAFETY: Use truck or trailer that will support the weight of the machine.

NOTE: Empty the hopper before transporting the machine.

2. If the loading surface is not horizontal or is higher than 380 mm (15 in) from the ground, use a winch to load machine.

If the loading surface is horizontal AND is 380 mm (15 in) or less from the ground, the machine may be driven onto the truck or trailer.

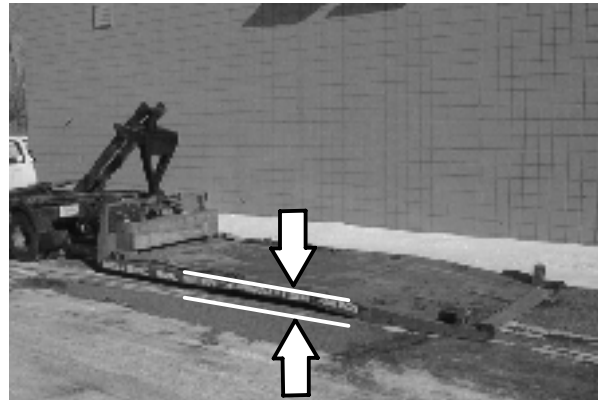

3. To winch the machine onto the truck or trailer, attach the winching chains to the rear tie down locations. The rear tie-down locations are the holes in the sides of the machine frame near the rear bumper.

FOR SAFETY: When loading machine onto truck or trailer, use winch. Do not drive the machine onto the truck or trailer unless the loading surface is horizontal AND is 380 mm (15 in) or less from the ground.

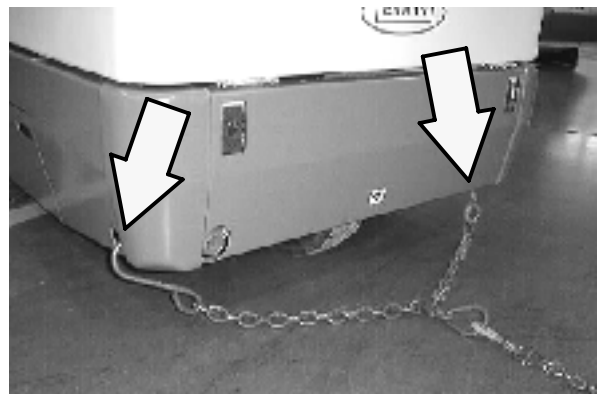

4. Position the machine onto the truck or trailer as far as possible. If the machine starts to veer off the centerline of the truck or trailer, stop and turn the steering wheel to center the machine.
5. Set the parking brake and block the machine tires. Tie down the machine to the truck or trailer before transporting.

The front tie-down locations are the holes in the wheel pockets at the front of the machine frame.



The rear tie-down locations are the holes in the sides of the machine frame near the rear bumper.



6. If the loading surface is not horizontal or is higher than 380 mm (15 in) from the ground, use a winch to unload machine.

If the loading surface is horizontal AND is 380 mm (15 in) or less from the ground, the machine may be driven off the truck or trailer.

FOR SAFETY: When unloading machine off truck or trailer, use winch. Do not drive the machine off the truck or trailer unless the loading surface is horizontal AND 380 mm (15 in) or less from the ground.

MAINTENANCE

MACHINE JACKING

Empty the hopper before jacking the machine. You can jack up the machine for service at the designated locations. Use a hoist or jack that will support the weight of the machine. Always stop the machine on a flat, level surface and block the tires before jacking up the machine.

FOR SAFETY: Before leaving or servicing machine, stop on level surface, set parking brake, turn off machine, and remove key.

The front jacking locations are on the flat bottom edge of the front of the machine frame next to the front tires.



The rear jacking location is the center of the rear bumper.

FOR SAFETY: When servicing machine, block machine tires before jacking up machine.

FOR SAFETY: When servicing machine, jack up machine at designated locations only. Block machine up with jack stands.

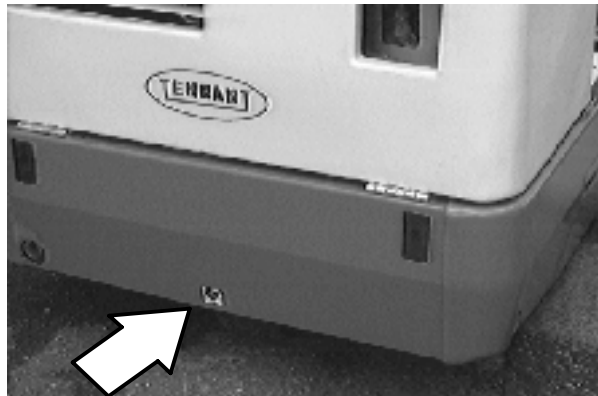

STORING MACHINE

Before storing the machine for an extended time, the machine needs to be serviced to lessen the chance of rust, sludge, and other undesirable deposits from forming.

SPECIFICATIONS

GENERAL MACHINE DIMENSIONS/CAPACITIES

Item	Dimension/capacity	
Length	2085 mm	(82 in)
Length with side brush	2260 mm	(89 in)
Width	1230 mm	(48.4 in)
Width with side brush	1395 mm	(55 in)
Height	1435 mm	(56.5 in)
Height with overhead guard	2085 mm	(82 in)
Track	1135 mm	(44.7 in)
Wheelbase	1135 mm	(44.7 in)
Main sweeping brush diameter	355 mm	(14 in)
Main sweeping brush length	915 mm	(36 in)
Side brush diameter	585 mm	(23 in)
Sweeping path width	915 mm	(36 in)
Sweeping path width with side brush	1270 mm	(50 in)
Main sweeping brush pattern width	50 to 75 mm	(2 to 3 in)
Hopper weight capacity	315 kg	(700 lb)
Hopper volume capacity	315 L	(11.25 ft ³)
Dust filter area	6.9 m ²	(74 ft ²)
GVWR	2041 kg	(4500 lb)
Ceiling height minimum dumping clearance	2340 mm	(92 in)

GENERAL MACHINE PERFORMANCE

Item	Measure	
Maximum forward speed	8 km/h	(5 mph)
Maximum reverse speed	4.8 km/h	(3 mph)
Minimum aisle turn width, left	2360 mm	(93 in)
Minimum turning radius, right	1490 mm	(58.7 in)
Minimum turning radius, left	1135 mm	(44.7 in)
Maximum rated incline with empty hopper	10° / 17.6%	
Maximum rated incline with full hopper	8° / 14.1%	

SPECIFICATIONS

POWER TYPE

Type	Quantity	Volts	Ah Rating	Weight
Batteries	6	6	315 @ hr rate	58 kg (127 lb)
	2	18	340 @ hr rate	254 kg (560 lb)
	2	18	425 @ hr rate	299 kg (660 lb)

Type	Use	VDC	Kw (hp)
Electric Motors	Propelling	36	1.6 (2.1)
	Accessory	36	3 (4)

Type	VDC	A	Hz	Phase	VAC
Chargers	36	50	60	1	240
	36	75	60	1	variable
	36	75	60	3	variable
	36	50	50	1	230
	36	75	50	3	variable
	36	45	50/60	1	variable

STEERING

Type	Power source	Emergency steering
Rear wheel, hydraulic cylinder and rotary valve controlled	Hydraulic accessory pump	Manual

HYDRAULIC SYSTEM

System	Capacity	Fluid Type
Hydraulic reservoir	10.6 L (2.8 gal)	TENNANT part no. 65870
Hydraulic total	12.1 L (3.2 gal)	
Propelling gearbox	2.6 L (2.7 qt)	SAE 90 Gear weight lubricant

BRAKING SYSTEM

Type	Operation
Service brakes	Mechanical drum brakes (2), one per front wheel, cable actuated
Parking brake	Utilizes service brakes, cable actuated

TIRES

Location	Type	Size
Front (2)	Solid	406 x 89 x 308 (16 x 3 1/2 x 12 1/8)
Rear (1)	Solid	406 x 102 x 308 (16 x 4 x 12 1/8)

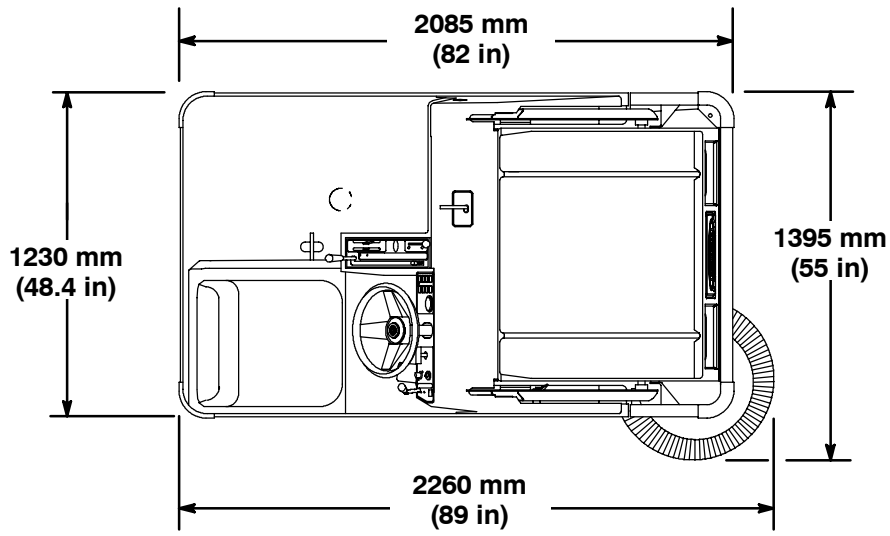

TOP VIEW

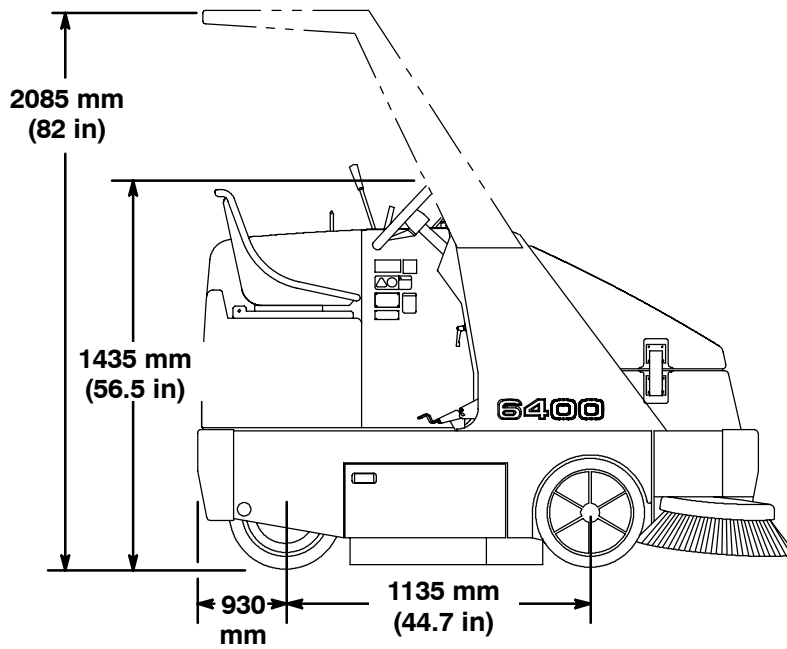

SIDE VIEW

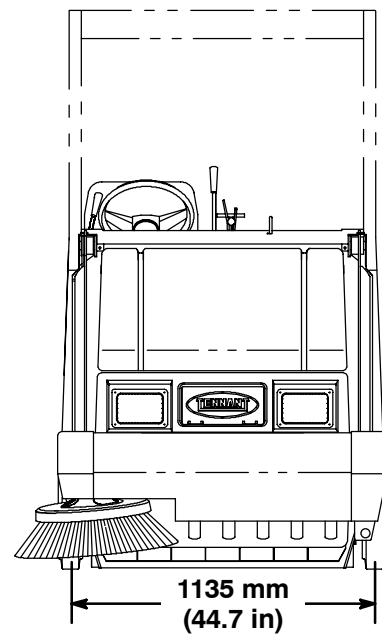

FRONT VIEW

MACHINE DIMENSIONS

350158-350165

INDEX**A**

Aisle turn, 63

B

Batteries, 44–48
Charger specifications, 64
Charging, 45–48
Discharge indicator, 15
Maintenance, 44
Specifications, 64

Battery discharge indicator, 15

Bearings
Front wheel, 41
Rear wheel support, 40

Belts, 47
Hydraulic pump, 47
Main brush, 48
Main brush intermediate, 48
Vacuum Fan, 48

Brake pedal, 11

Brakes, 21, 59
System specifications, 64

Brush door seals, 57

Brush door skirts, 56

Brushes, 23–26, 30, 51–56
Adjusting main brush taper, 53
Checking main brush pattern, 52–54
Checking side brush pattern, 54
Door seals, 57
Door skirts, 56
Main brush, 23, 51–54
Main brush bristle length, 51
Main brush down pressure knob, 13
Main brush lever, 12
Rear skirts, 57
Replacing main brush, 51–53
Replacing side brush, 54
Side brush, 24, 54–56
Side brush bristle length, 54
Side brush down pressure knob, 17
Side brush dust control skirts, 57
Side brush guard, 55
Side brush lever, 16
Side brush pivot, 55

Button, Horn, 16

C

Capacities, 63

Chains, 47
Static drag, 48

Circuit breakers, 18

Clogged filter light, 14

Control panel
Battery discharge indicator, 15
Clogged filter light, 14
Hopper door closed light, 14
Hopper temperature light, 14
Hourmeter, 15
Hydraulic filter bypass light, 14
Operating lights switch, 17
Operating/hazard lights switch, 17

Controls, 9
Battery discharge indicator, 15
Brake pedal, 11
Circuit breakers, 18
Clogged filter light, 14
Directional pedal, 10
Fuse, 18
Hopper door closed light, 14
Hopper door lever, 12
Hopper lever, 12
Hopper temperature light, 14
Horn button, 16
Hourmeter, 15
Hydraulic filter bypass light, 14
Main brush down pressure knob, 13
Main brush lever, 12
On-off key switch, 16
Operating lights switch, 17
Operating/hazard lights switch, 17
Operation, 10
Parking brake pedal, 11
Power kill switch, 13
Seat support release lever, 11
Side brush down pressure knob, 17
Side brush lever, 16
Steering wheel, 15
Steering wheel tilt handle, 16
Symbols, 7–9
Vacuum and filter shaker lever, 13

D

Debris hopper, 49–51
 Deluxe suspension seat, 19
 Dimensions, 63
 Directional pedal, 10
 Disengaging hopper support bar, 33–35
 Doors
 Brush
 Seals, 57
 Skirts, 56
 Hopper, Seals, 58
 Hopper access, Seal, 58
 Dust filter, 49–51
 Changing, 50–52
 Cleaning, 49

E

Electric motors, 47, 64
 Electrical
 Batteries, 44–48
 Charging batteries, 45–48
 Circuit breakers, 18
 Fuse, 18
 On-off key switch, 16
 Emptying the hopper, 27–30
 Engaging hopper support bar, 31–33

F

Front wheel, Bearings, 41
 Front wheel bearings, 41
 Fuses, 18

G

Grease fittings
 Hopper lift arm pivots, 41
 Rear wheel support, 40
 Steering link, 41

H

Hopper
 Access door seal, 58
 Changing dust filter, 50–52
 Cleaning dust filter, 49

Clogged filter, Light, 14
 Debris, 49–51
 Disengaging hopper support bar, 33–35
 Door closed, Light, 14
 Door lever, 12
 Door seals, 58
 Dust filter, 49–51
 Emptying the hopper, 27–30
 Engaging hopper support bar, 31–33
 Lever, 12
 Lift arm pivots, 41
 Lip skirt, 56
 Seals, 57
 Side skirt, 56
 Support bar, 20
 Temperature, Light, 14
 Thermo Sentry, 13, 14
 Vacuum fan seal, 58

Hopper access door seal, 58
 Hopper door closed light, 14
 Hopper door lever, 12
 Hopper door seals, 58
 Hopper lever, 12
 Hopper lift arm pivots, 41
 Hopper lip skirt, 56
 Hopper seals, 57
 Hopper side skirt, 56
 Hopper support bar, 20
 Hopper temperature light, 14
 Horn button, 16
 Hourmeter, 15
 How the machine works, 21
 Hydraulic filter bypass light, 14
 Hydraulic fluid, 42
 Hydraulic fluid reservoir, 42
 Hydraulic hoses, 43
 Hydraulic pump belt, 47
 Hydraulics, 42–44
 Filter bypass light, 14
 Fluid, 42–44
 Fluid filter, 42
 Fluid level, 42
 Hoses, 43
 Hydraulic pump belt, 47
 Reservoir, 42
 System specifications, 64

J

Jack points, 62
Jacking up the machine, 62

K

Knobs
Main brush down pressure, 13
Side brush down pressure, 17

L

Levers
Hopper, 12
Hopper door, 12
Main brush, 12
Seat support release, 11
Side brush, 16
Steering wheel tilt handle, 16
Vacuum and filter shaker, 13

Lights
Clogged filter, 14
Hopper door closed, 14
Hopper temperature, 14
Hydraulic filter bypass, 14
Operating lights switch, 17
Operating/hazard lights switch, 17

Lubrication, 40–42

M

Machine components, 6
Machine dimensions, 65
Machine jacking, 62
Machine leaks, 30
Machine tie down location, 61
Main brush, 23, 51–54
Adjust brush taper, 53
Belt, 48
Bristle length, 51
Checking brush pattern, 52–54
Door seals, 57
Door skirts, 56
Down pressure, 13
Intermediate belt, 48
Lever, 12
Maintenance, 51
Rear skirts, 57
Replacing, 51–53

Main brush belt, 48
Main brush down pressure knob, 13
Main brush intermediate belt, 48
Main brush lever, 12
Maintenance, 38
Intervals, 38–40
Recommended, 5
Maintenance chart, 38–40
Motors, Electric, 47, 64

O

On-off key switch, 16
Operating lights switch, 17
Operating/hazard lights switch, 17
Operation, 5
Operation on inclines, 34
Operator Responsibility, 5
Operator seat, 19
Options, 35–37
Clogged filter light, 14
Hopper door closed light, 14
Hydraulic filter bypass light, 14
Operating lights switch, 17
Operating/hazard lights switch, 17
Power kill, 13
Side brush dust control skirts, 57
Vacuum Wand, 35

P

Parking brake pedal, 11
Pedal, Directional, 10
Pedals
Brake, 11
Parking brake, 11
Pivots
Hopper lift arm, 41
Side brush, 55

Post-operation checklist, 30
 Power kill switch, 13
 Pre-operation checklist, 21
 Propelling gearbox, 40
 Pushing machine, 60
 Pushing or towing the machine, 60
 Pushing, towing, and transporting machine, 60

R

Rear skirts, 57
 Rear wheel, 59
 Steering link, 41
 Support, 40
 Rear wheel support, 40
 Bearings, 40
 Grease fitting, 40

S

Safety
 Disengaging hopper support bar, 33–35
 Engaging hopper support bar, 31–33
 Hopper support bar, 20
 Labels, 4
 Precautions, 3–5
 Seals, 56–59
 Brush doors, 57
 Hopper, 57
 Hopper access door, 58
 Hopper door, 58
 Vacuum fan, 58
 Seat
 Adjustment, 19
 Deluxe suspension, 19
 Operator, 19
 Seat support, Release lever, 11
 Seat support release lever, 11
 Service records, 30
 Side brush, 24, 54–56
 Bristle length, 54
 Checking brush pattern, 54
 Down pressure, 17
 Dust control skirts, 57
 Guard, 55
 Lever, 16
 Pivot, 55
 Replacing, 54

Side brush down pressure knob, 17
 Side brush dust control skirts, 57
 Side brush guard, 55
 Side brush lever, 16
 Side brush pivot, 55
 Skirts, 30, 56–59
 Brush doors, 56
 Hopper Lip, 56
 Hopper side, 56
 Rear, 57
 Side brush dust control, 57

Specifications, 63–66
 Braking system, 64
 Chargers, 64
 Electric motors, 64
 Hydraulic system, 64
 Machine capacities, 63
 Machine dimensions, 63
 Machine performance, 63
 Power type, 64
 Steering, 64
 Tires, 64

Starting the machine, 22
 Static drag chain, 48
 Steering, 21
 Specifications, 64
 Steering link, 41
 Grease fitting, 41
 Steering wheel, 15
 Steering wheel tilt handle, 16
 Stop sweeping, 26
 Stop the machine, 29
 Storing machine, 62
 Sweeping, 25
 Sweeping and brush information, 23–26
 Switches
 On-off key, 16
 Operating lights, 17
 Operating/hazard lights, 17
 Power kill, 13

T

Thermo Sentry, 13, 14
 Tie down location, 61
 Tires, 59
 Rear wheel, 59

Specifications, 64
Towing machine, 60
Transporting machine, 60
Transporting the machine, 60
Travel speed, 63
Troubleshooting, 37

V

Vacuum and filter shaker lever, 13
Vacuum fan
 Belt, 48
 Seal, 58
Vacuum fan belt, 48
Vacuum fan seal, 58
Vacuum Wand, 35

W

Wheel nuts, Torque, 59